

Name _____ Date _____

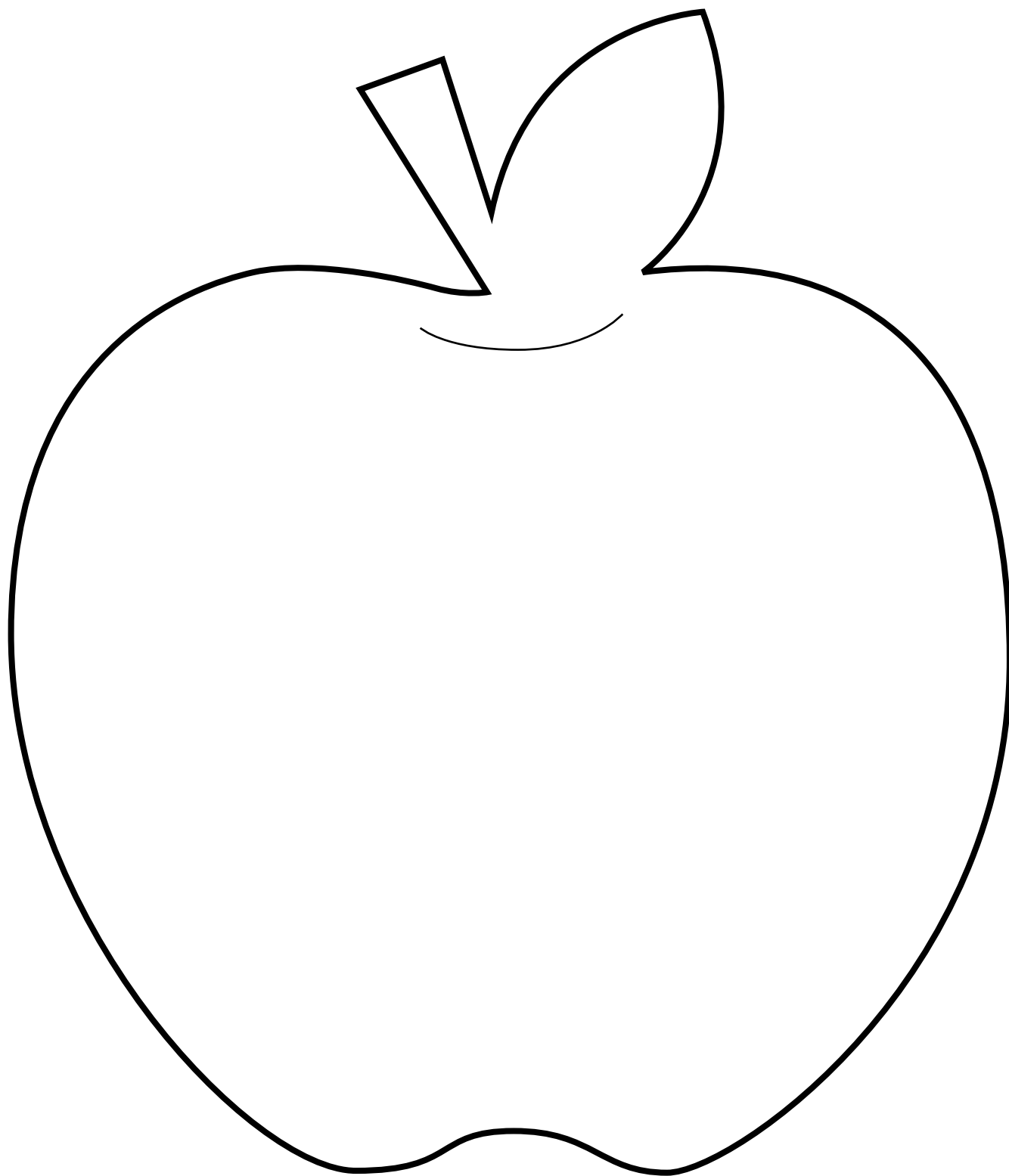

Name _____ Date _____

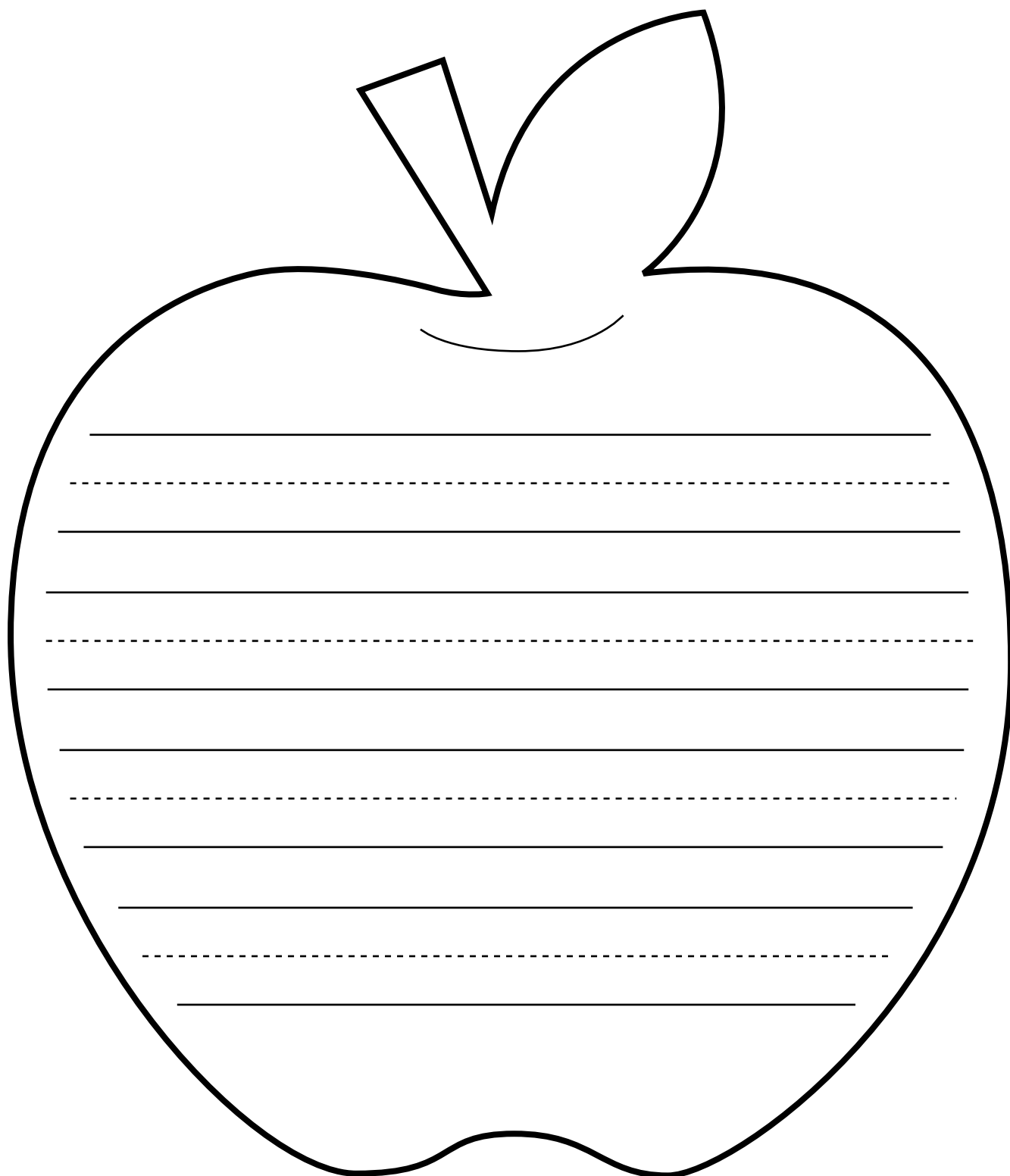

Name _____ Date _____

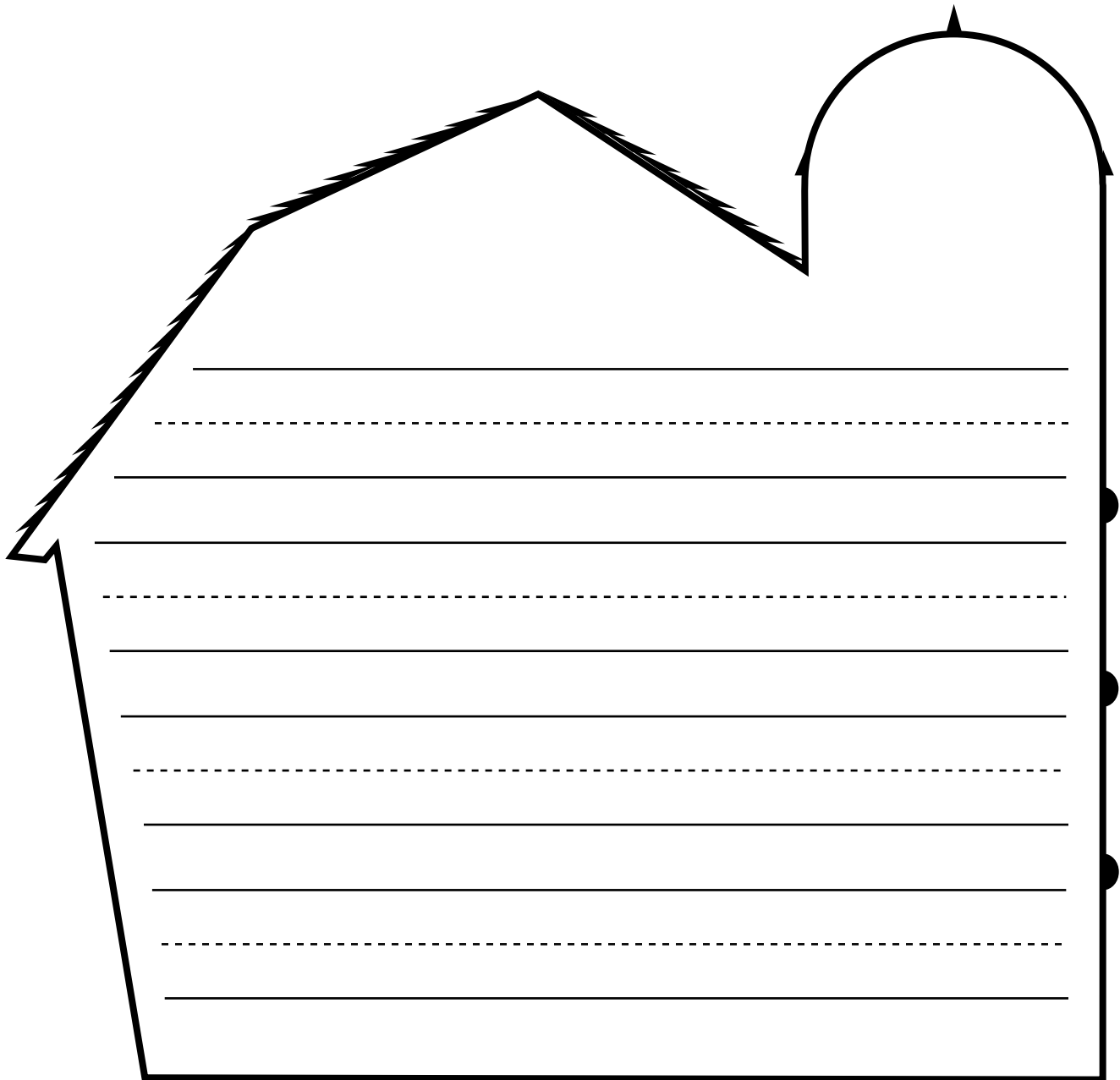

Name _____ Date _____

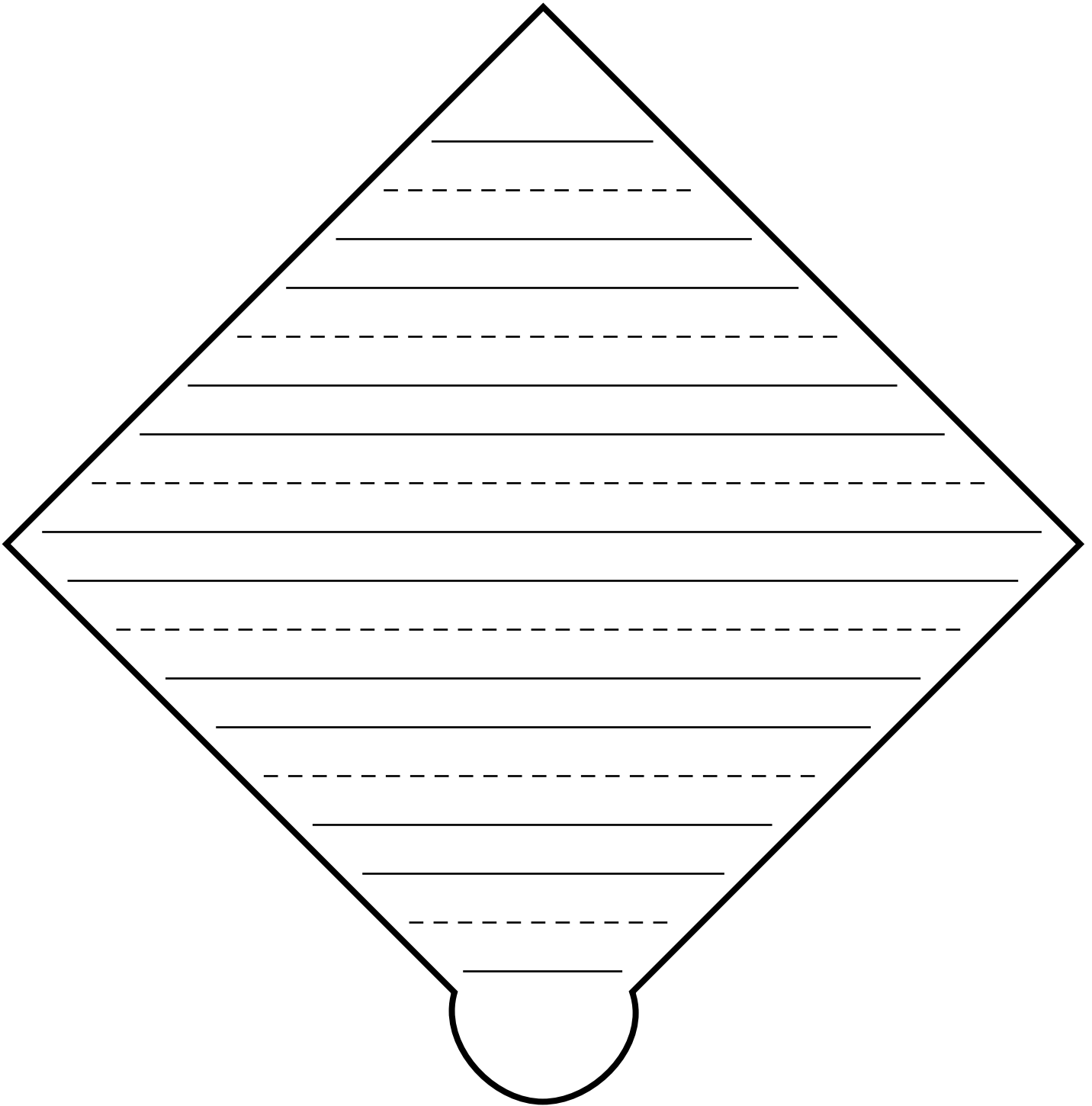

Name _____ Date _____

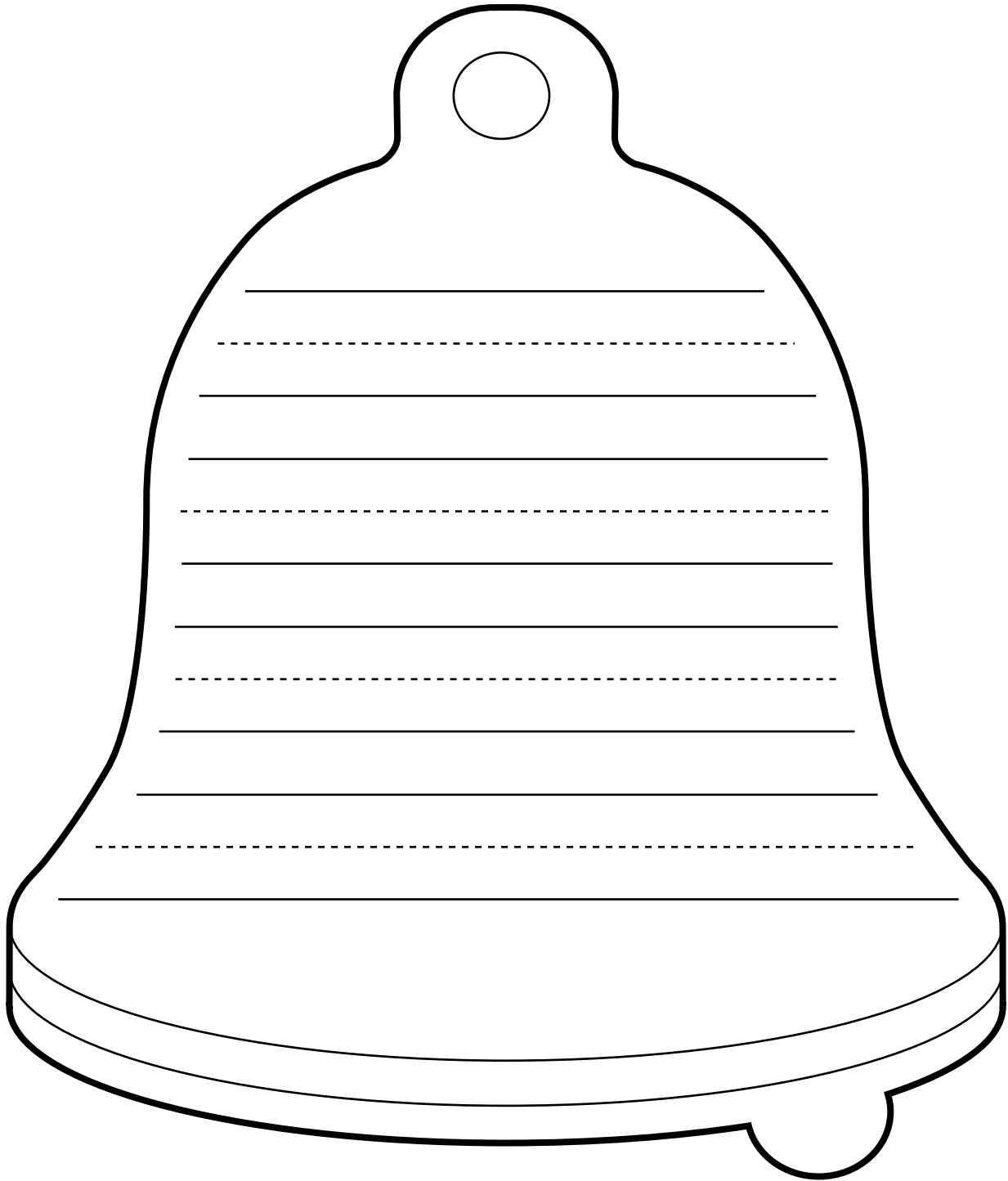

Name _____ Date _____

The writing area is divided into two main sections. The top section is a smaller, rounded rectangle with a decorative, scalloped top edge. It contains two sets of handwriting lines, each with a solid top line, a dashed middle line, and a solid bottom line. The bottom section is a larger, rounded rectangle with a decorative, scalloped top edge that matches the one above. It contains eight sets of handwriting lines, each with a solid top line, a dashed middle line, and a solid bottom line.

Name _____ Date _____

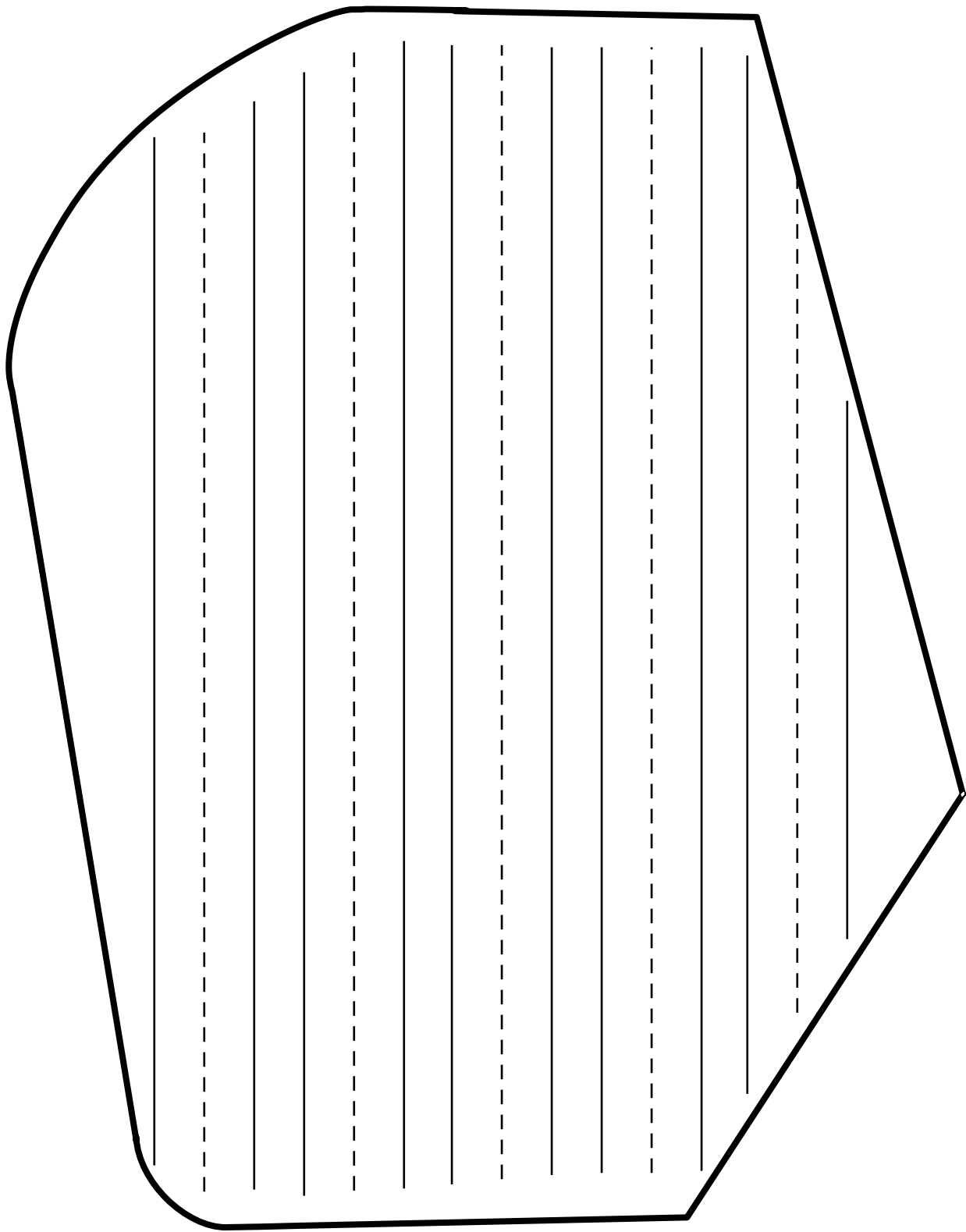

Name _____ Date _____

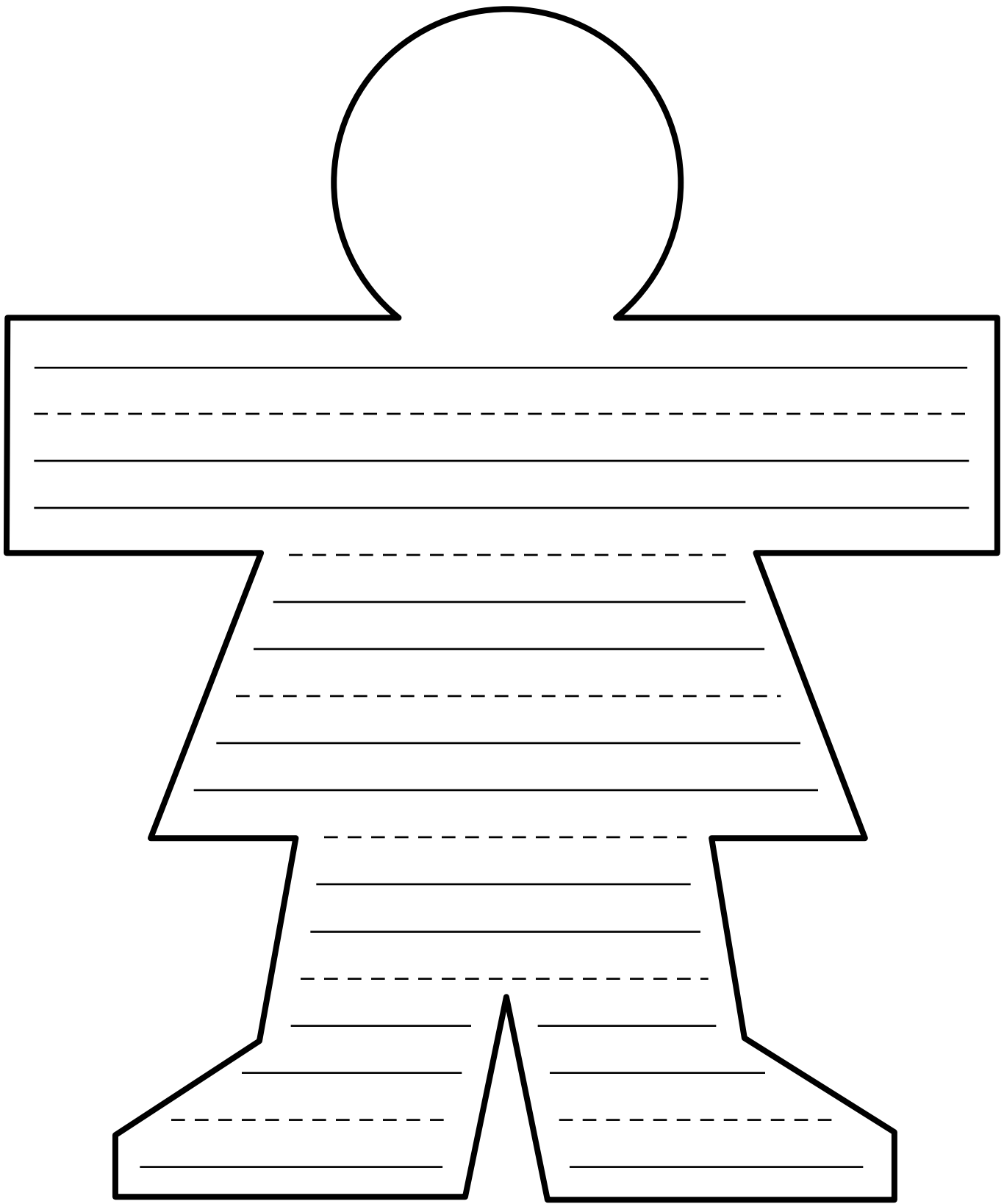

Name _____ Date _____

A large circle containing ten sets of handwriting lines. Each set consists of a solid top line, a dashed middle line, and a solid bottom line.

Name _____ Date _____

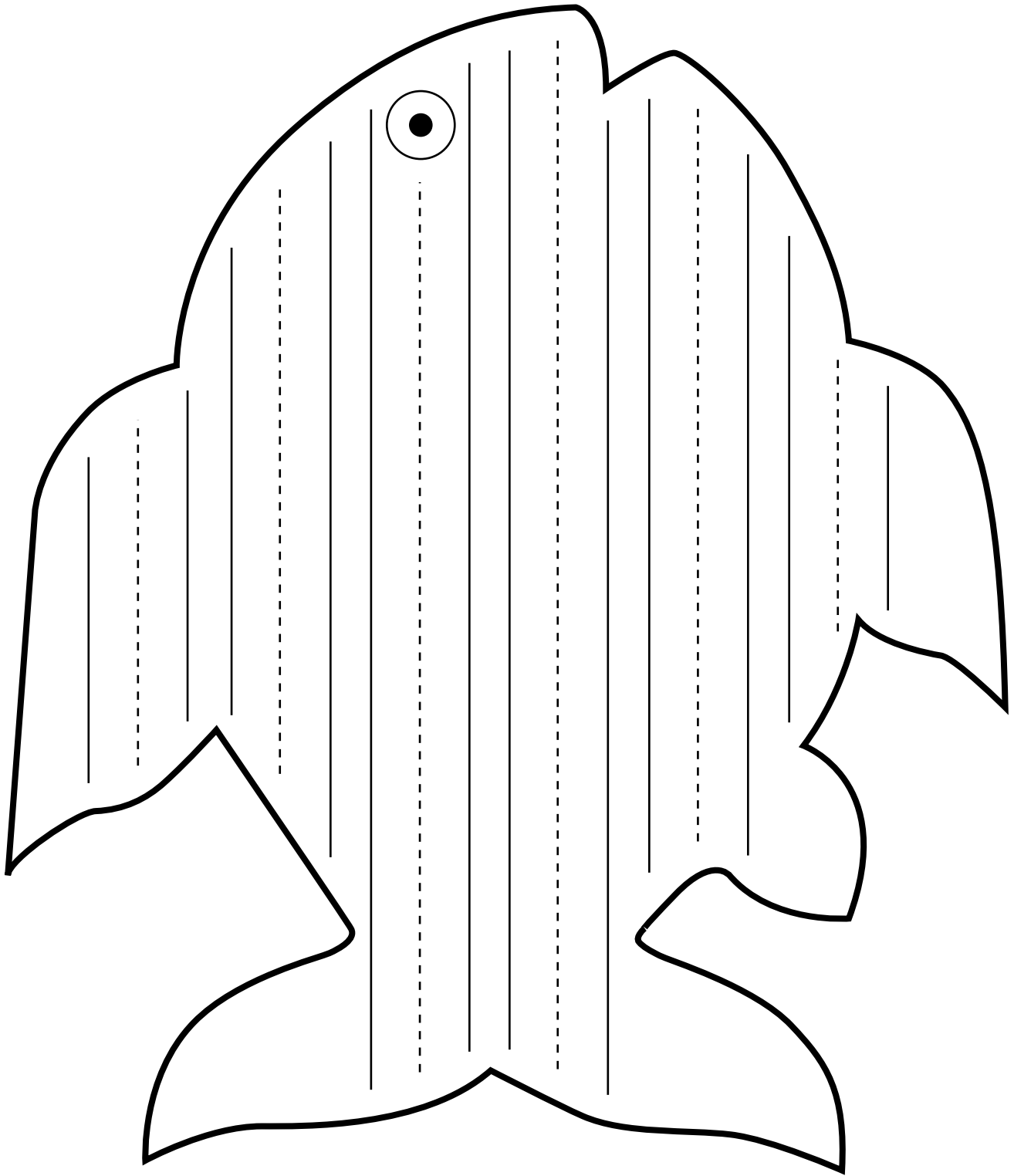

Name _____ Date _____

A large, irregular cloud-shaped outline is centered on the page. Inside the cloud, there are ten sets of horizontal lines for handwriting practice. Each set consists of three lines: a solid top line, a dashed middle line, and a solid bottom line. The lines are evenly spaced and fill the interior of the cloud.

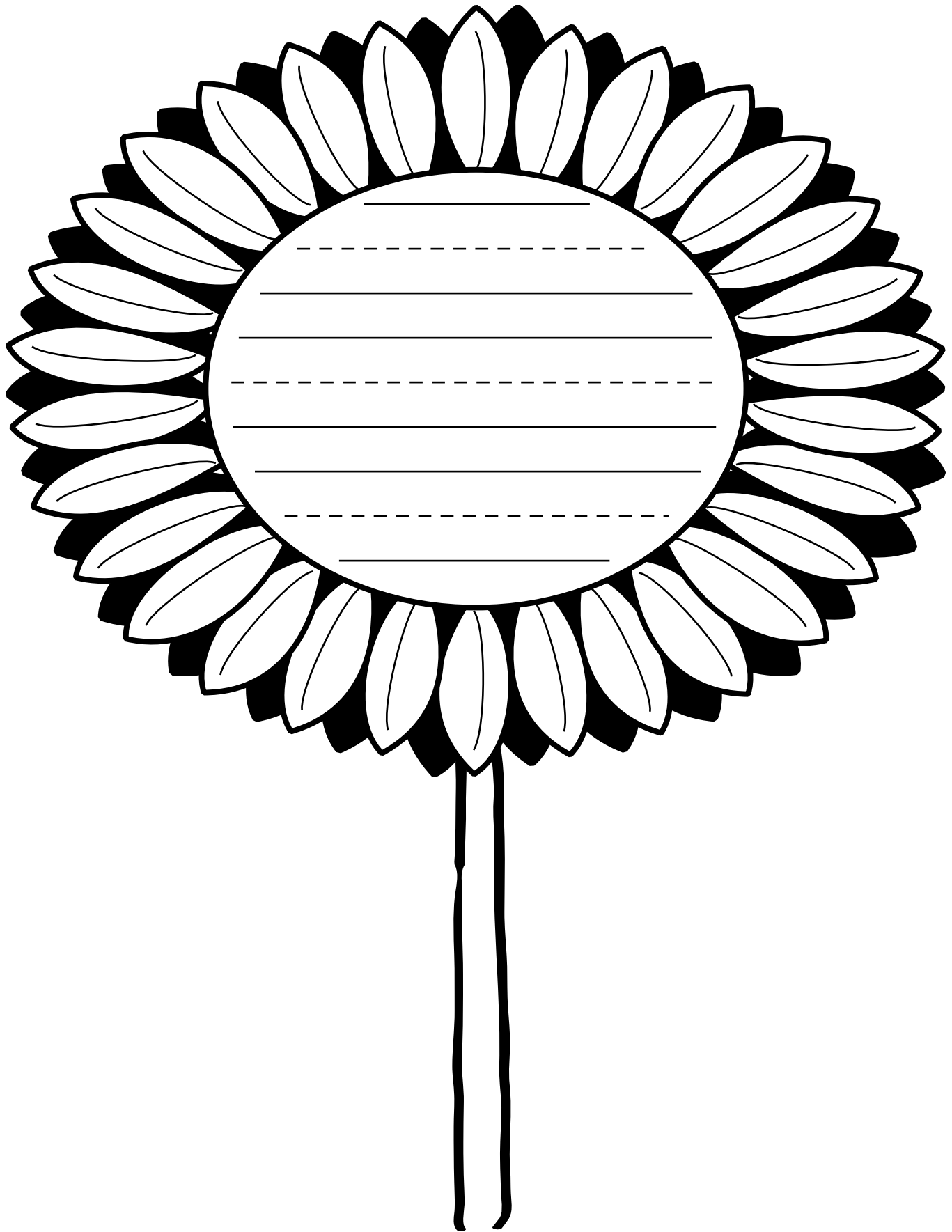

Name _____ Date _____

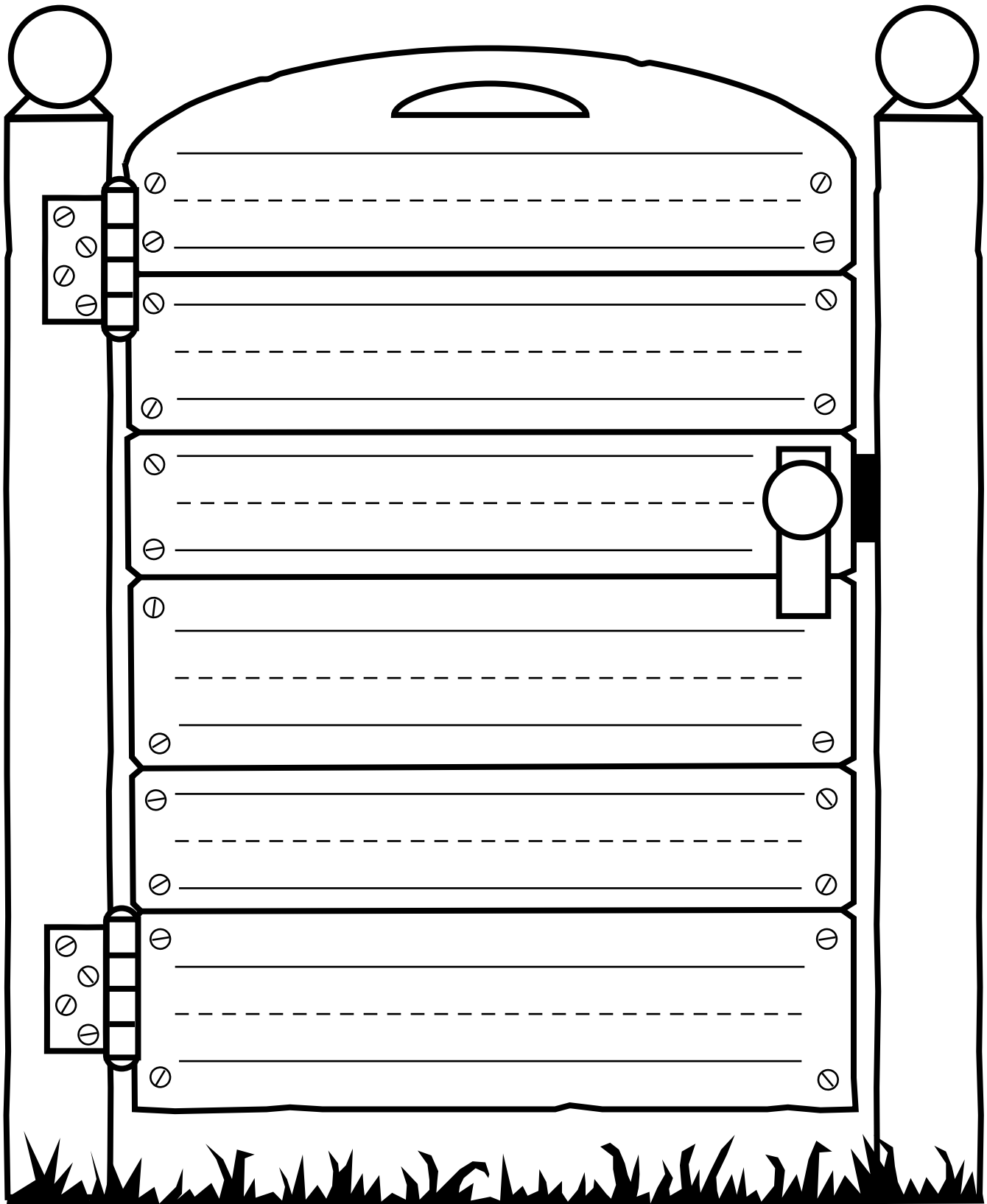

Name _____ Date _____

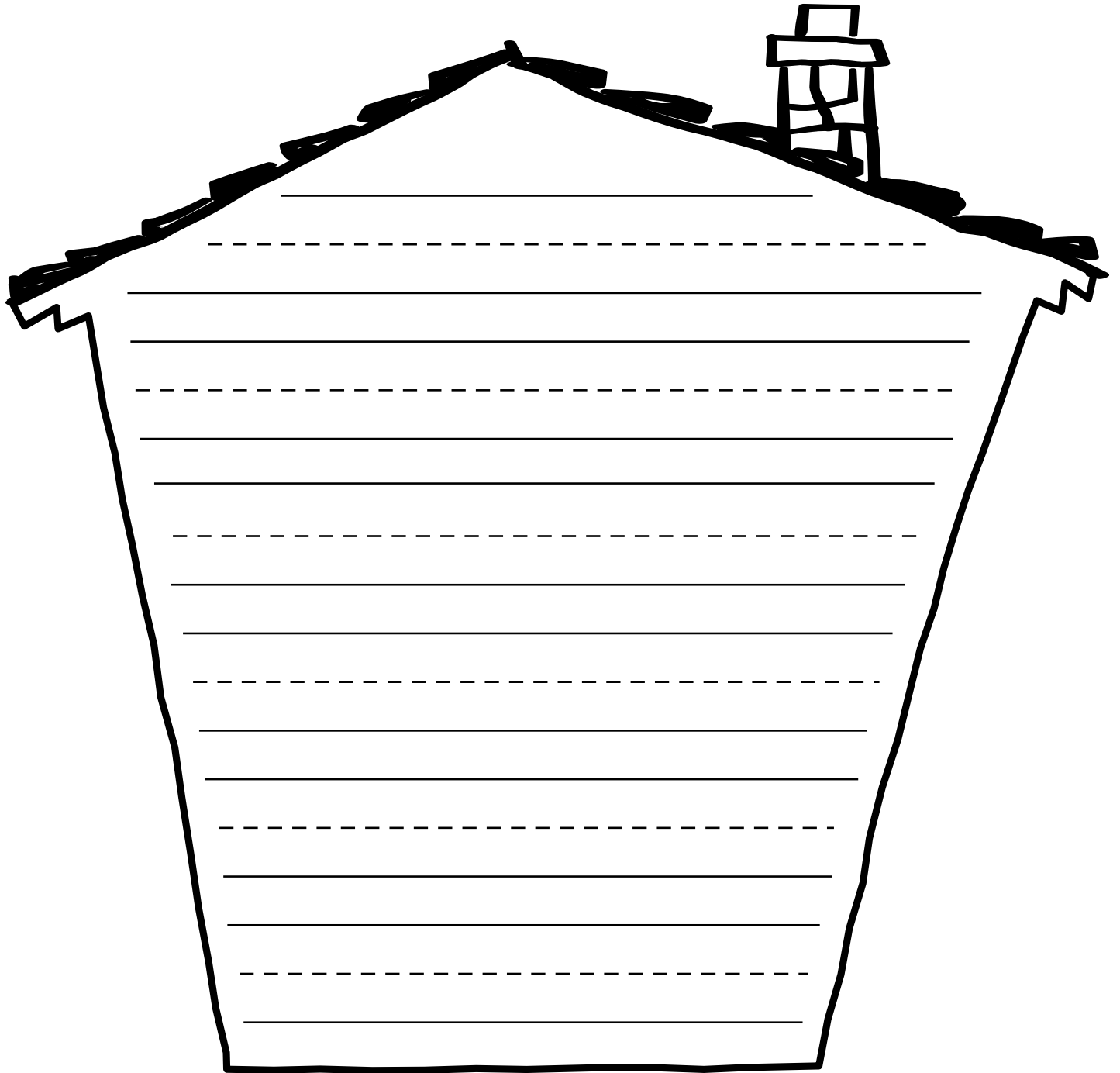

Name _____ Date _____

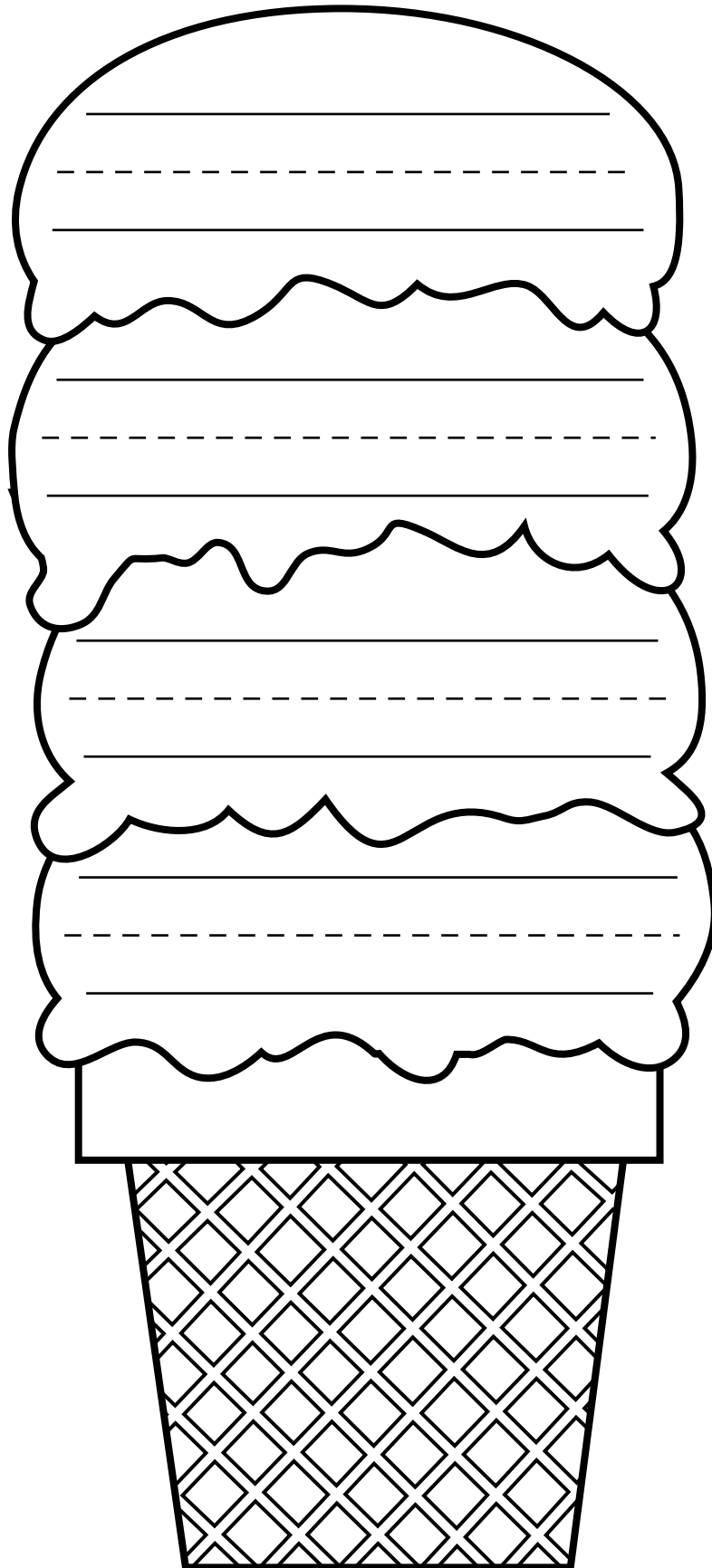

Name _____ Date _____

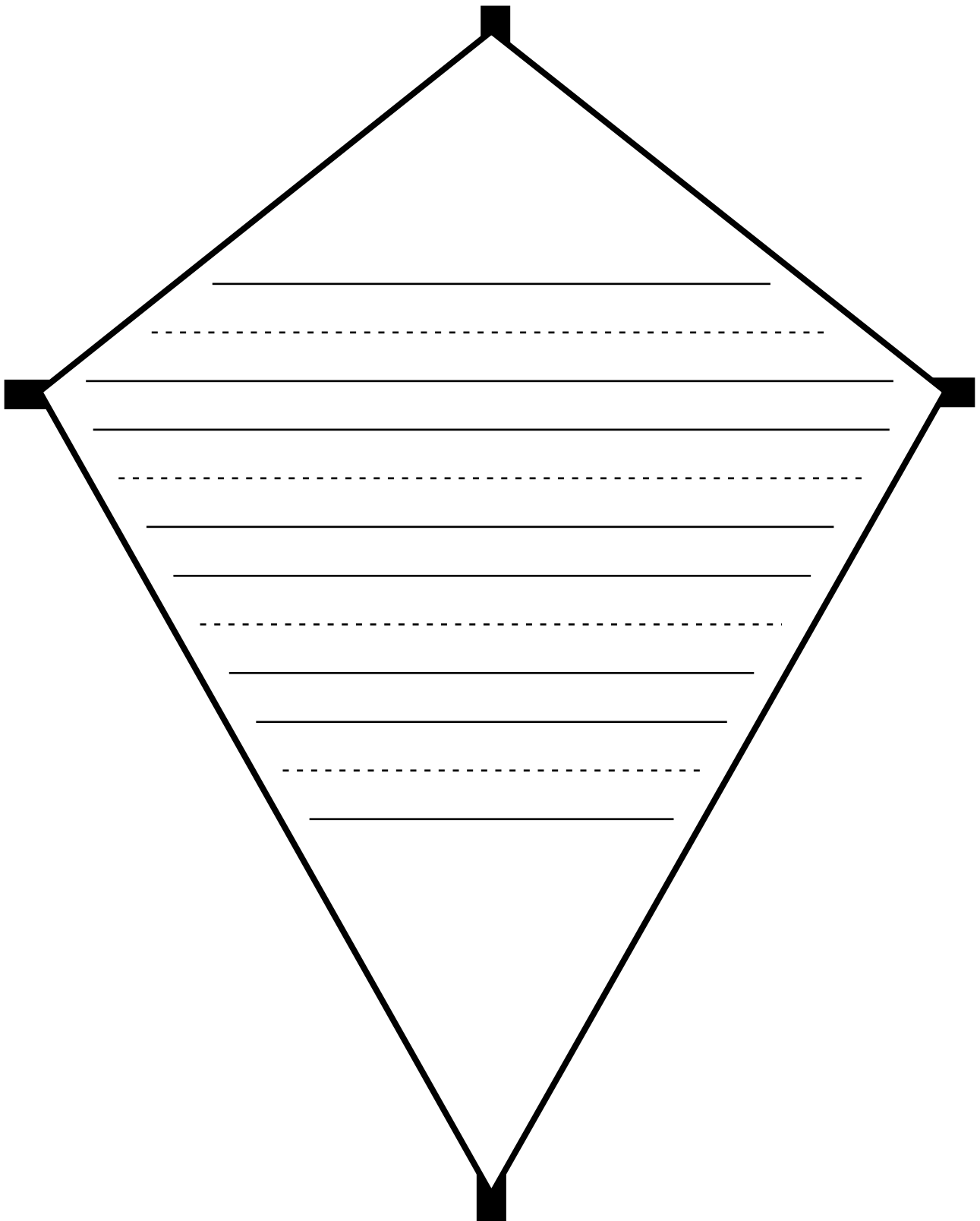

Name _____ Date _____

The image shows a vertical writing template. It consists of two columns of rounded rectangular boxes. Each box is divided into three horizontal sections by lines: a solid top line, a dashed middle line, and a solid bottom line. This layout is typical for teaching handwriting to children, where the dashed line helps guide the height of letters. There are five such boxes in each column, for a total of ten writing areas.

Name _____ Date _____

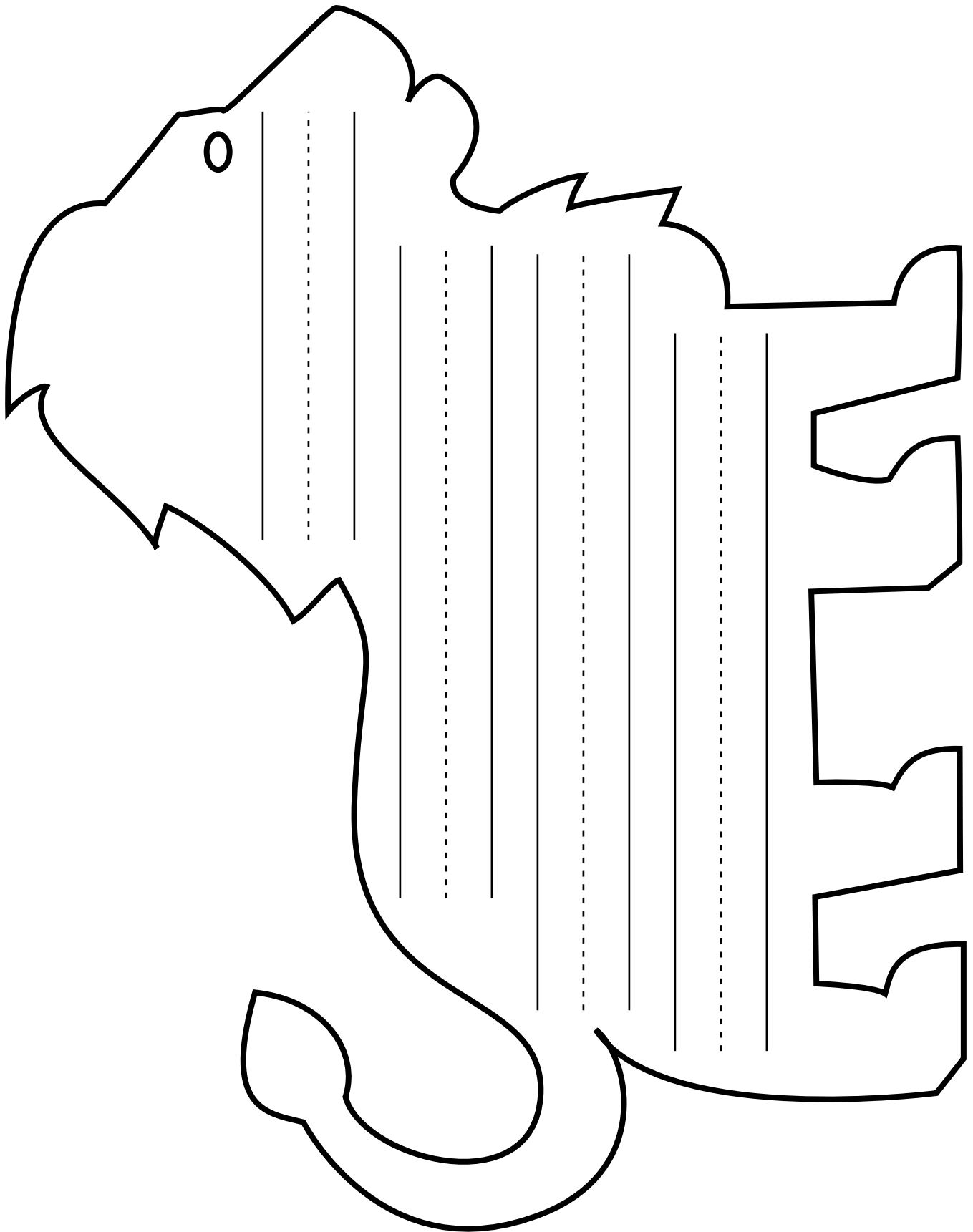

Name _____ Date _____

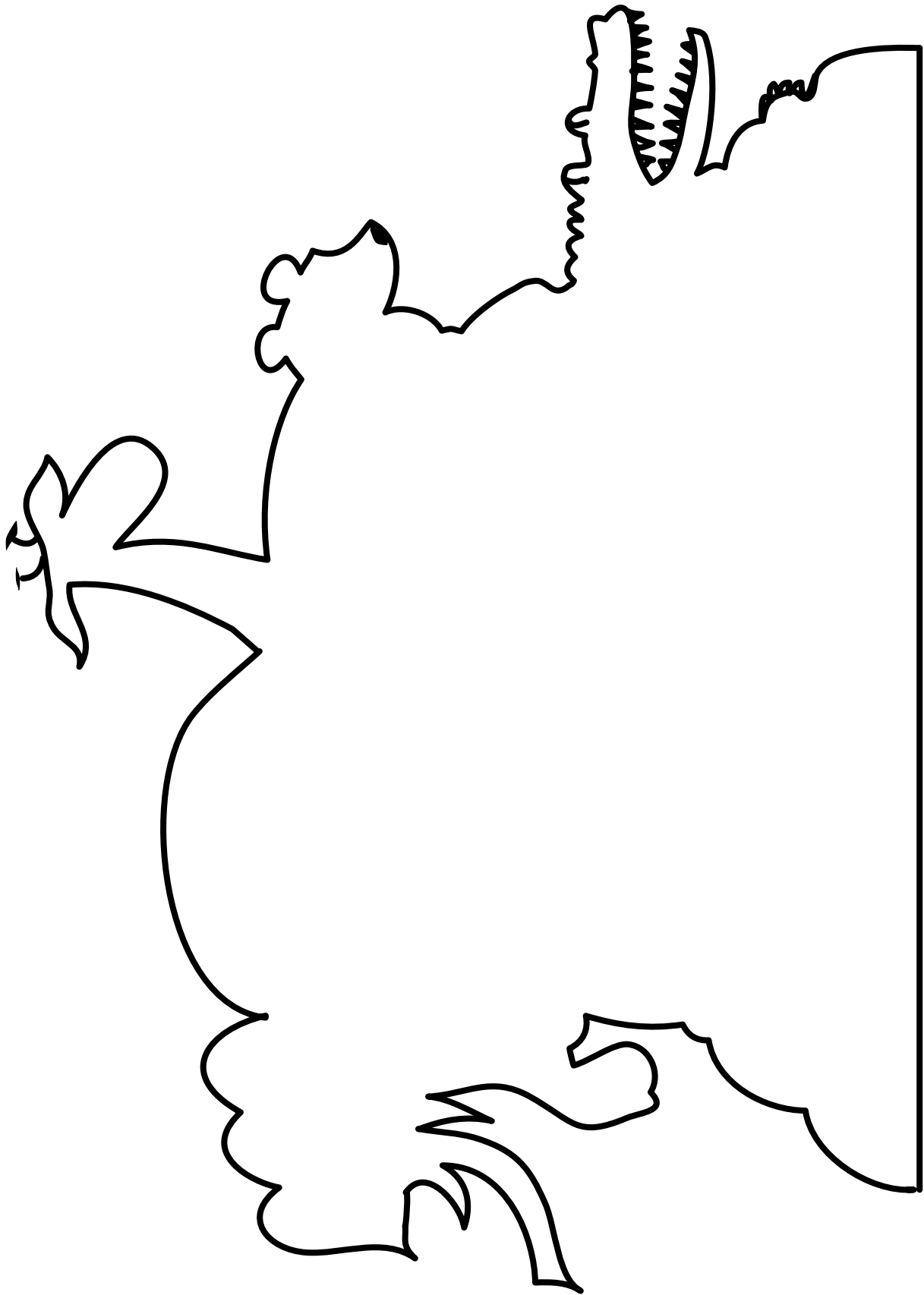

Name _____ Date _____

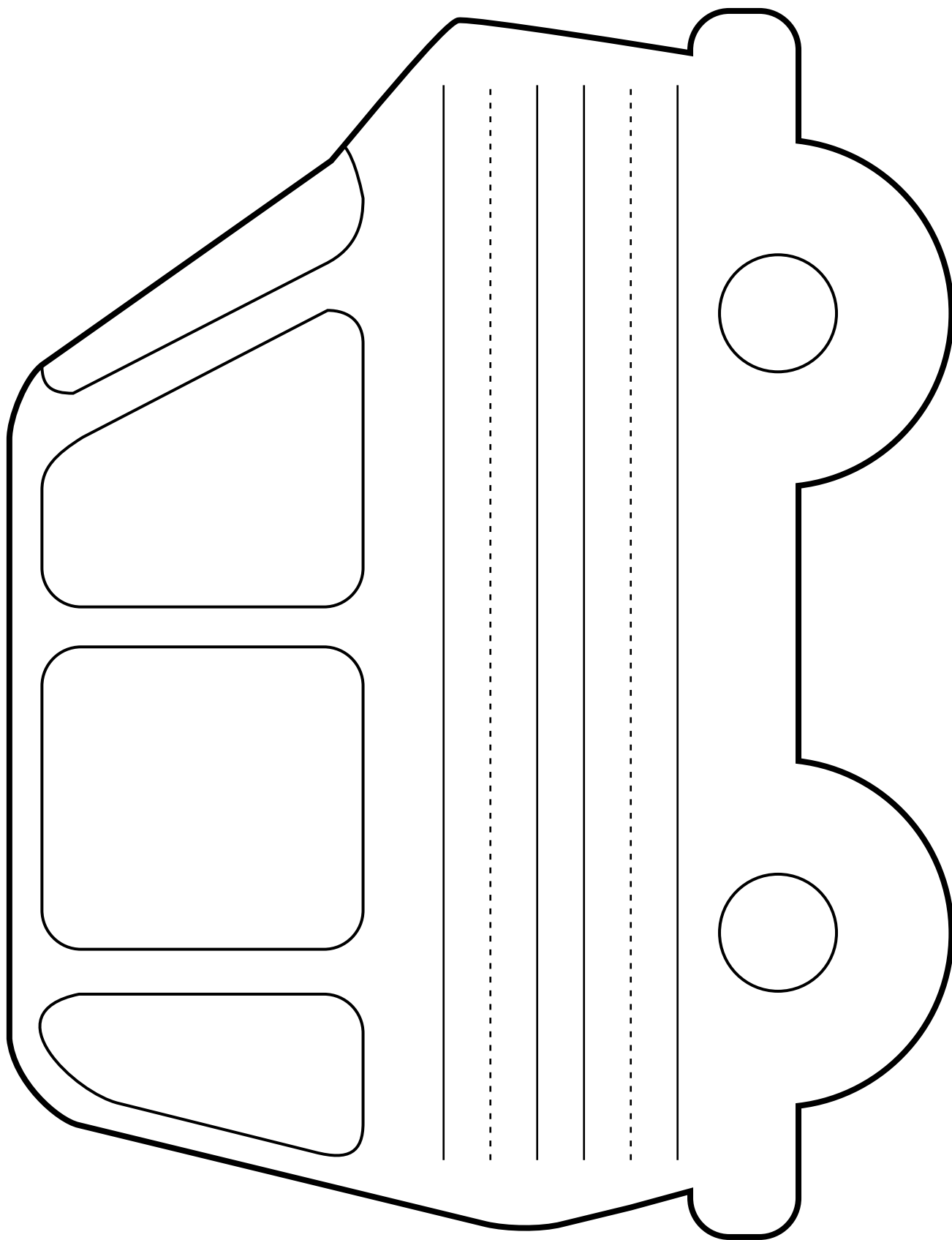

Name _____ Date _____

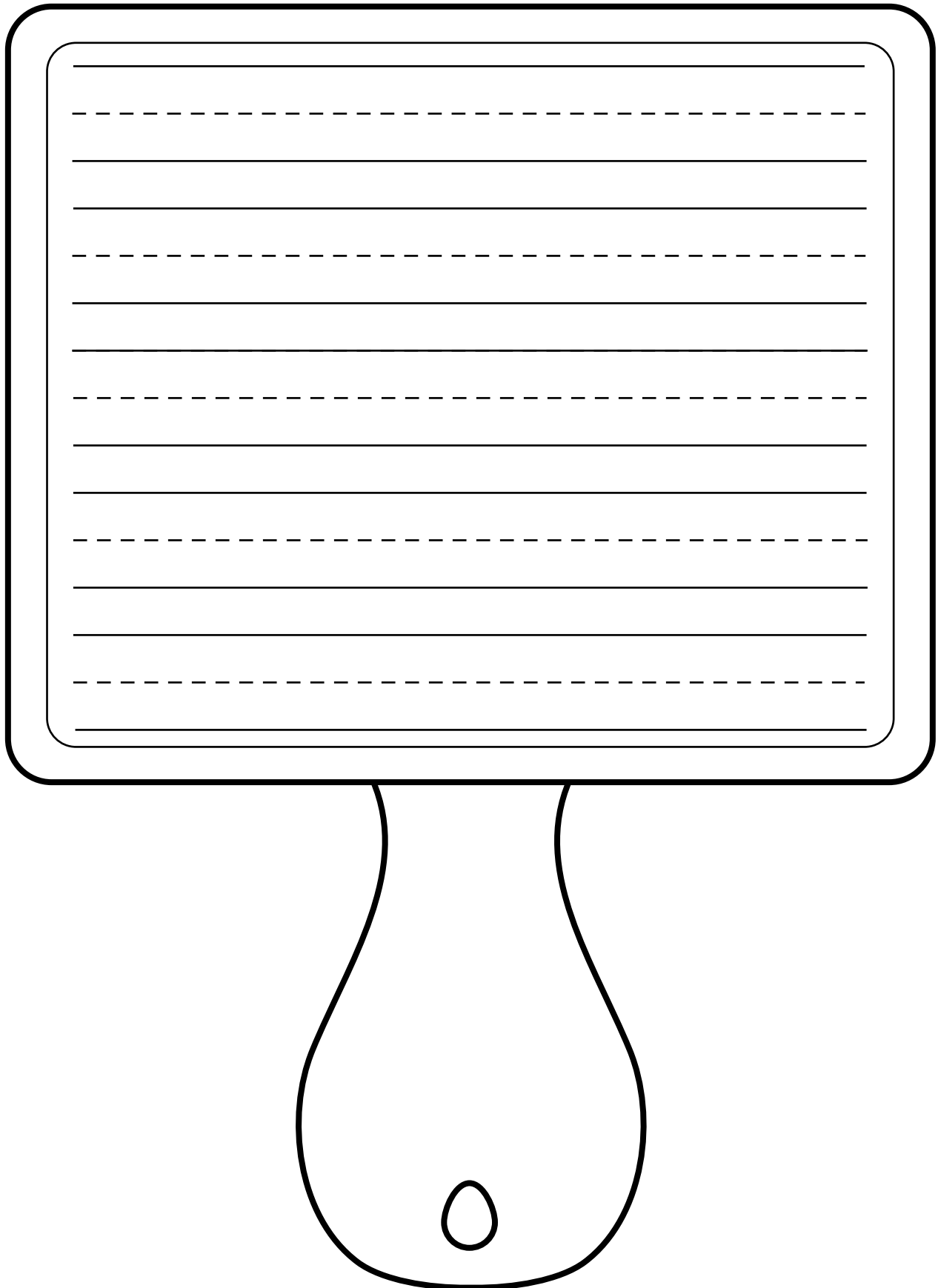

Name _____ Date _____

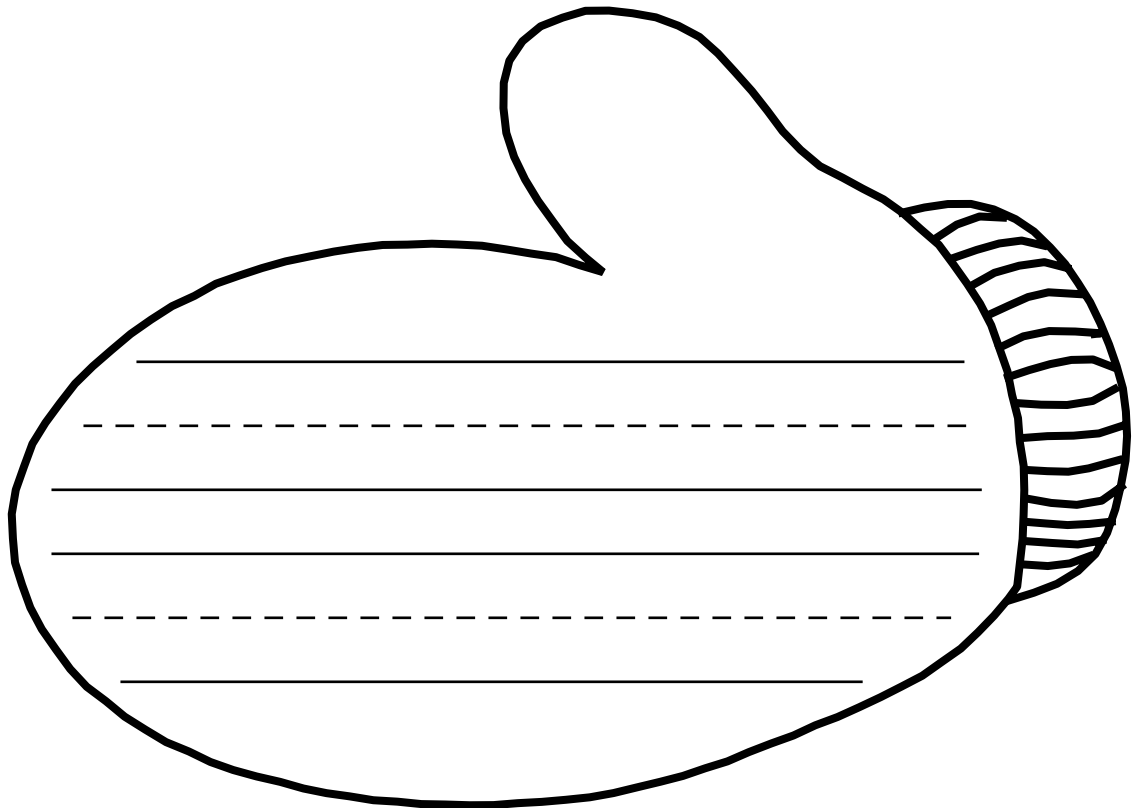
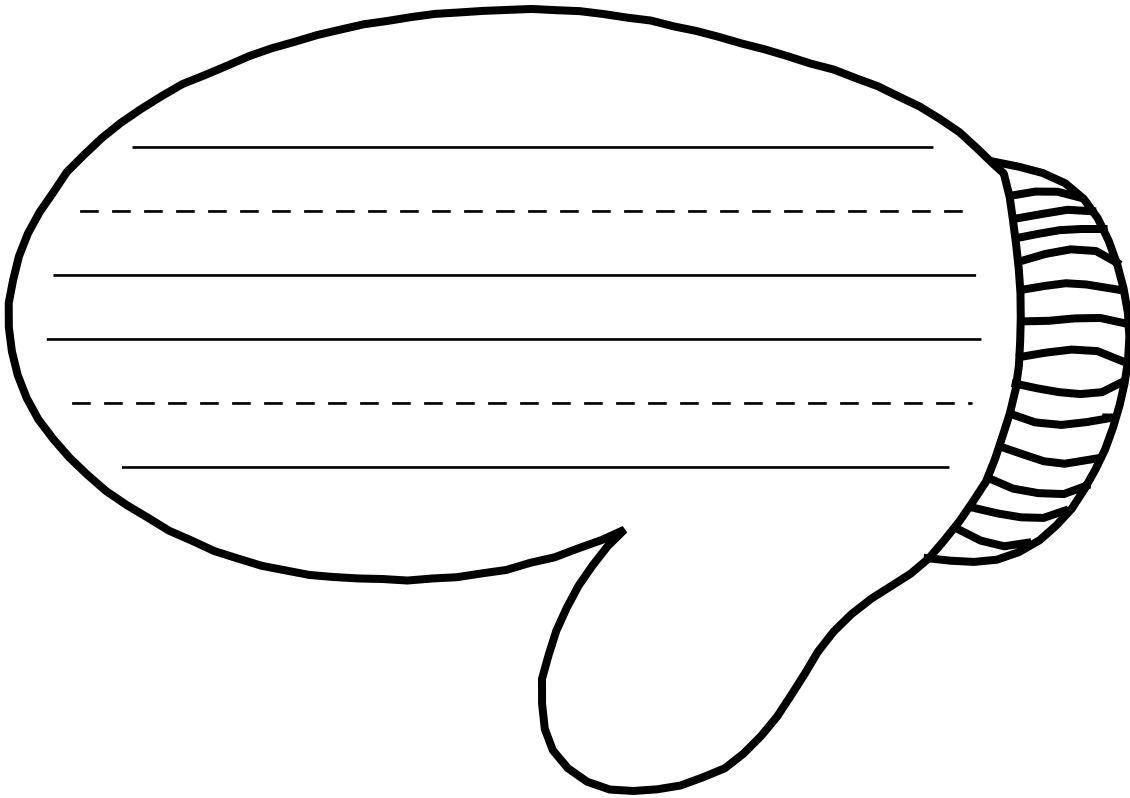

Name _____ Date _____

A large circle containing ten sets of handwriting lines. Each set consists of a solid top line, a dashed middle line, and a solid bottom line. The lines are arranged in a vertical column within the circle, providing a template for practicing letter formation.

Name _____ Date _____

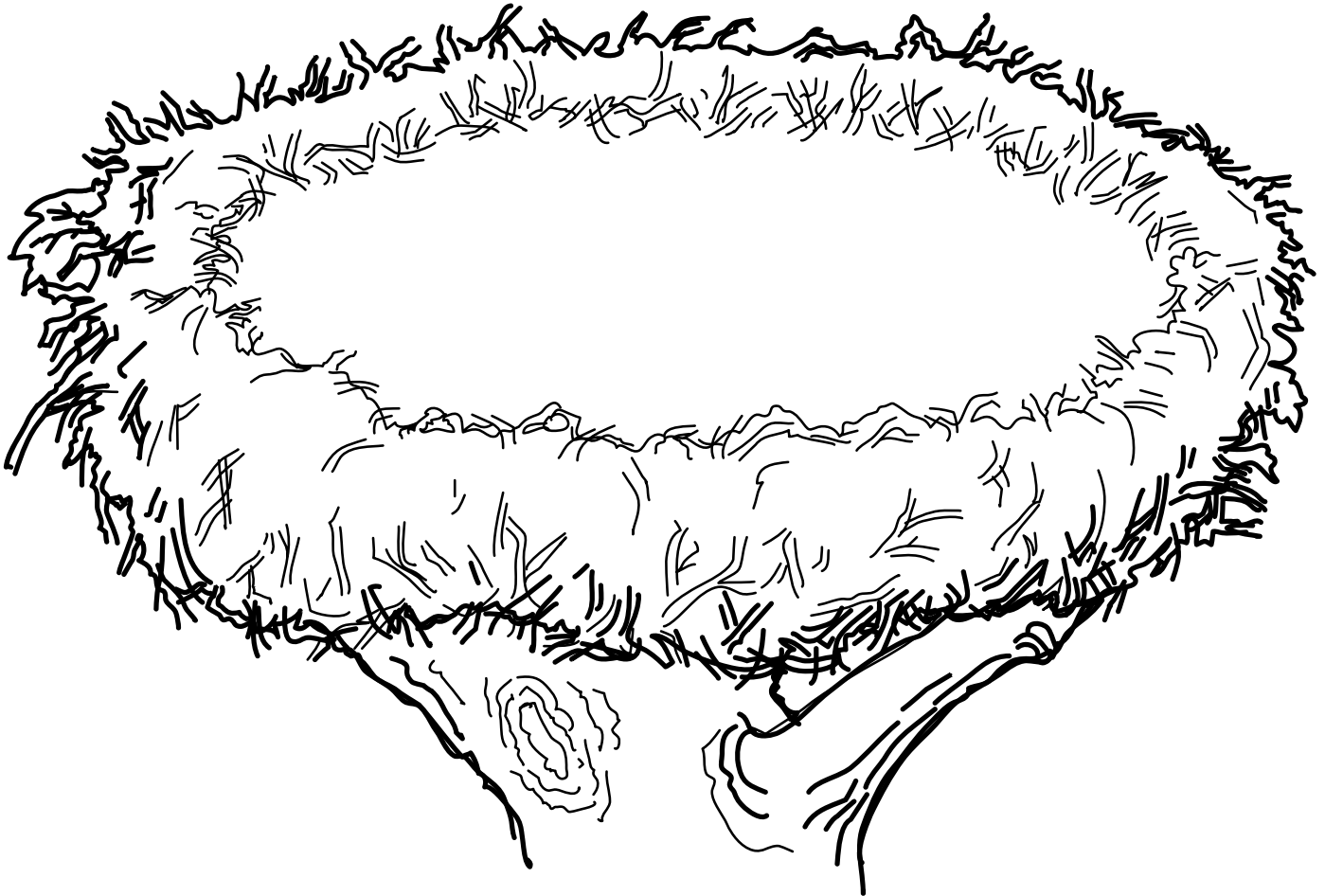
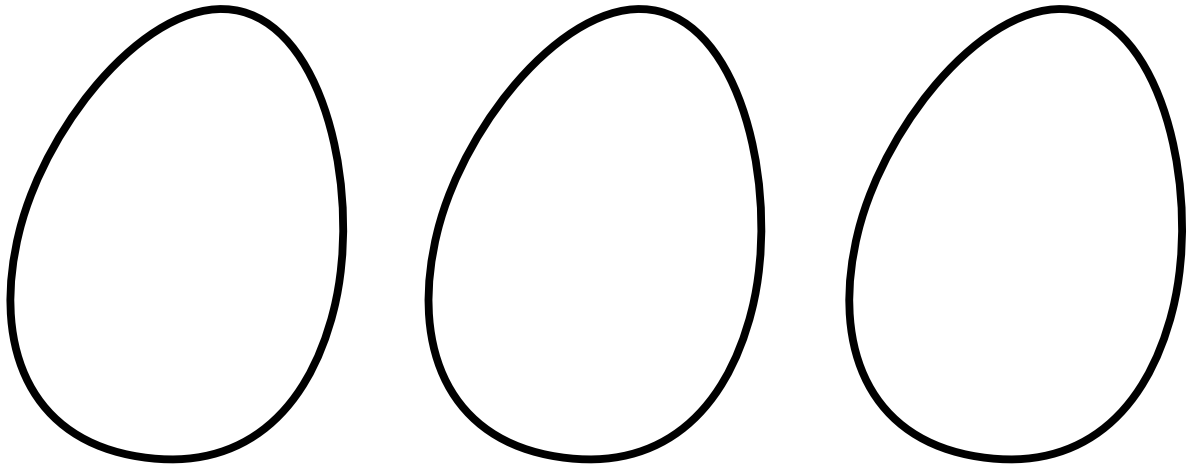

Name _____ Date _____

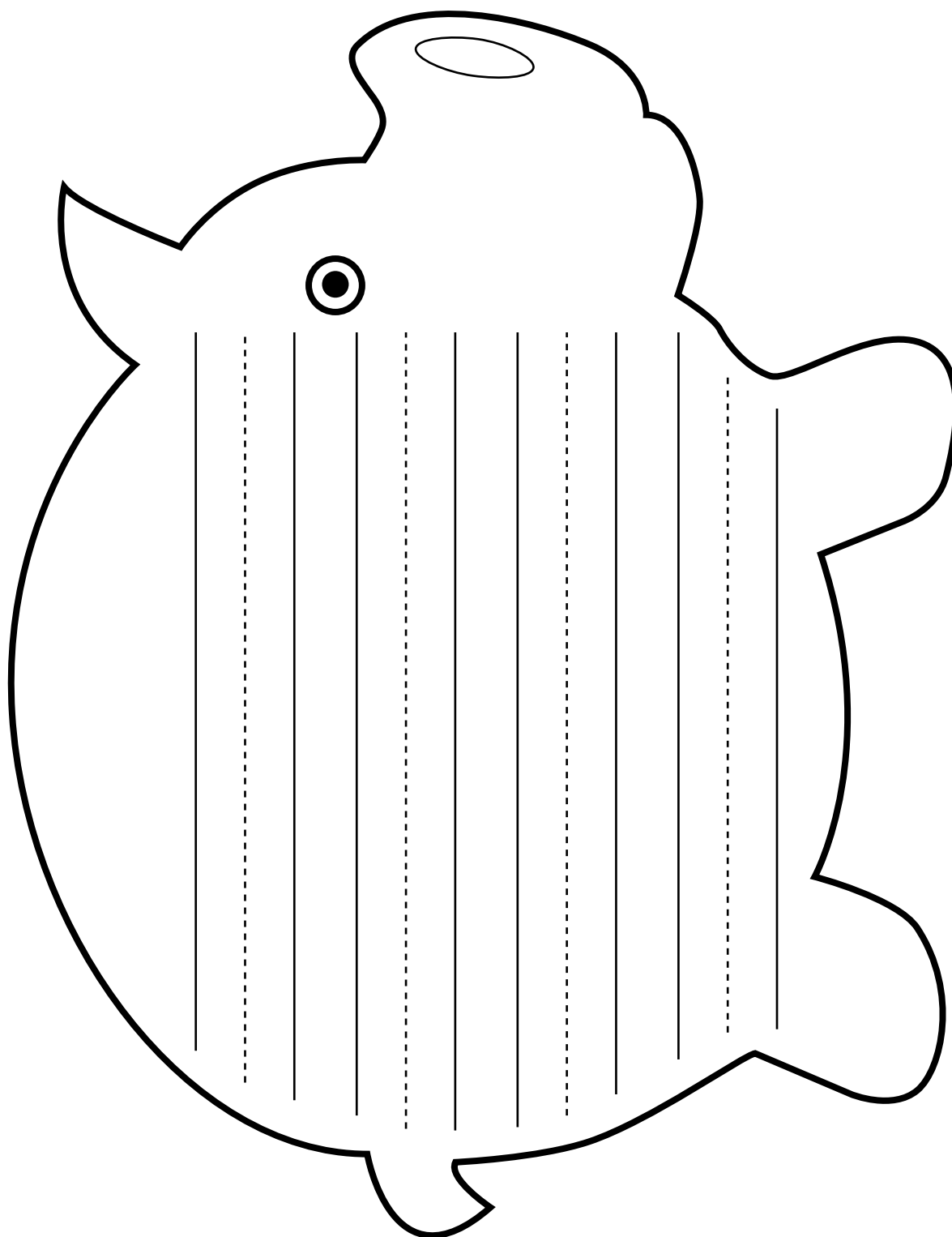

Name _____ Date _____

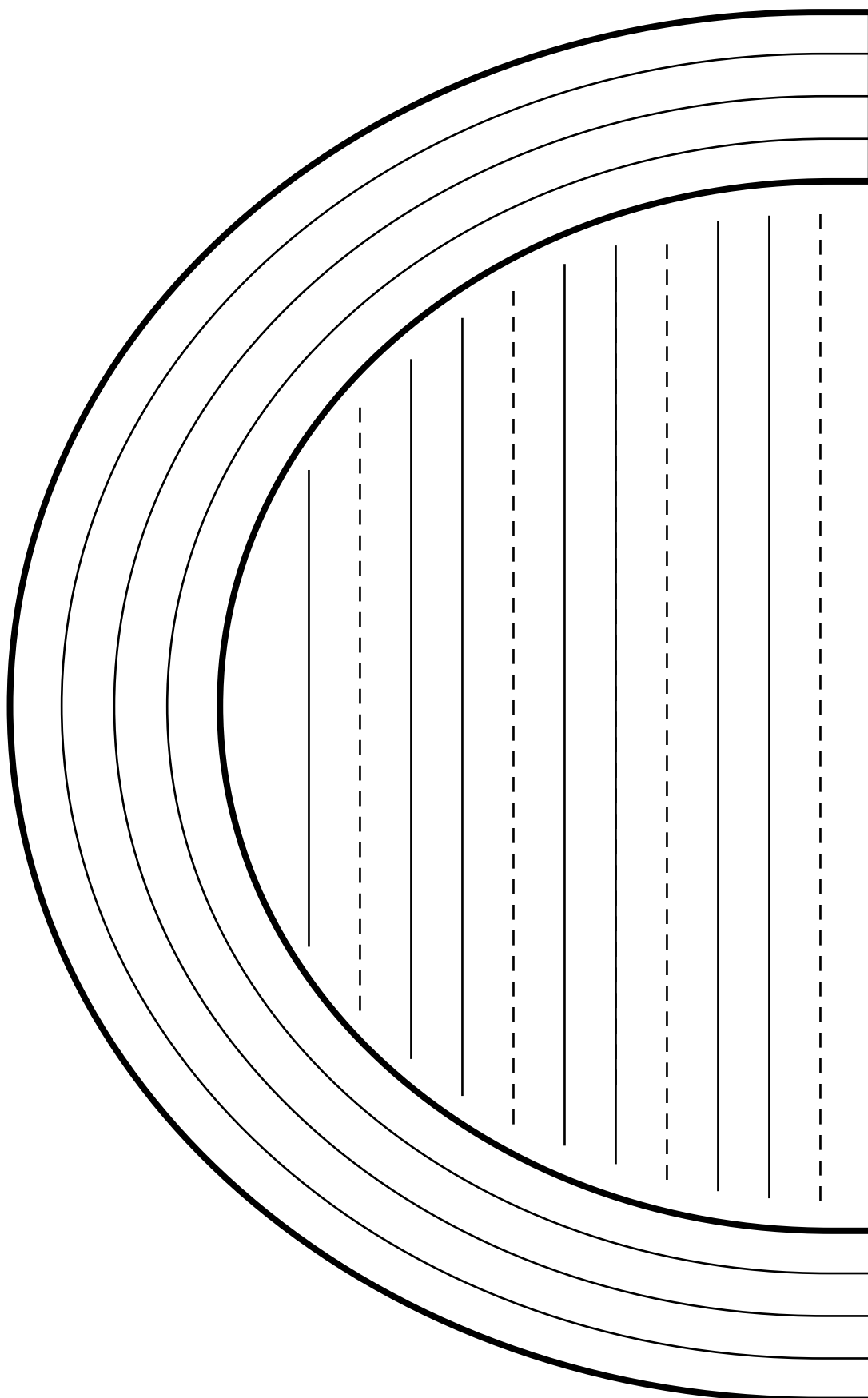

Name _____ Date _____

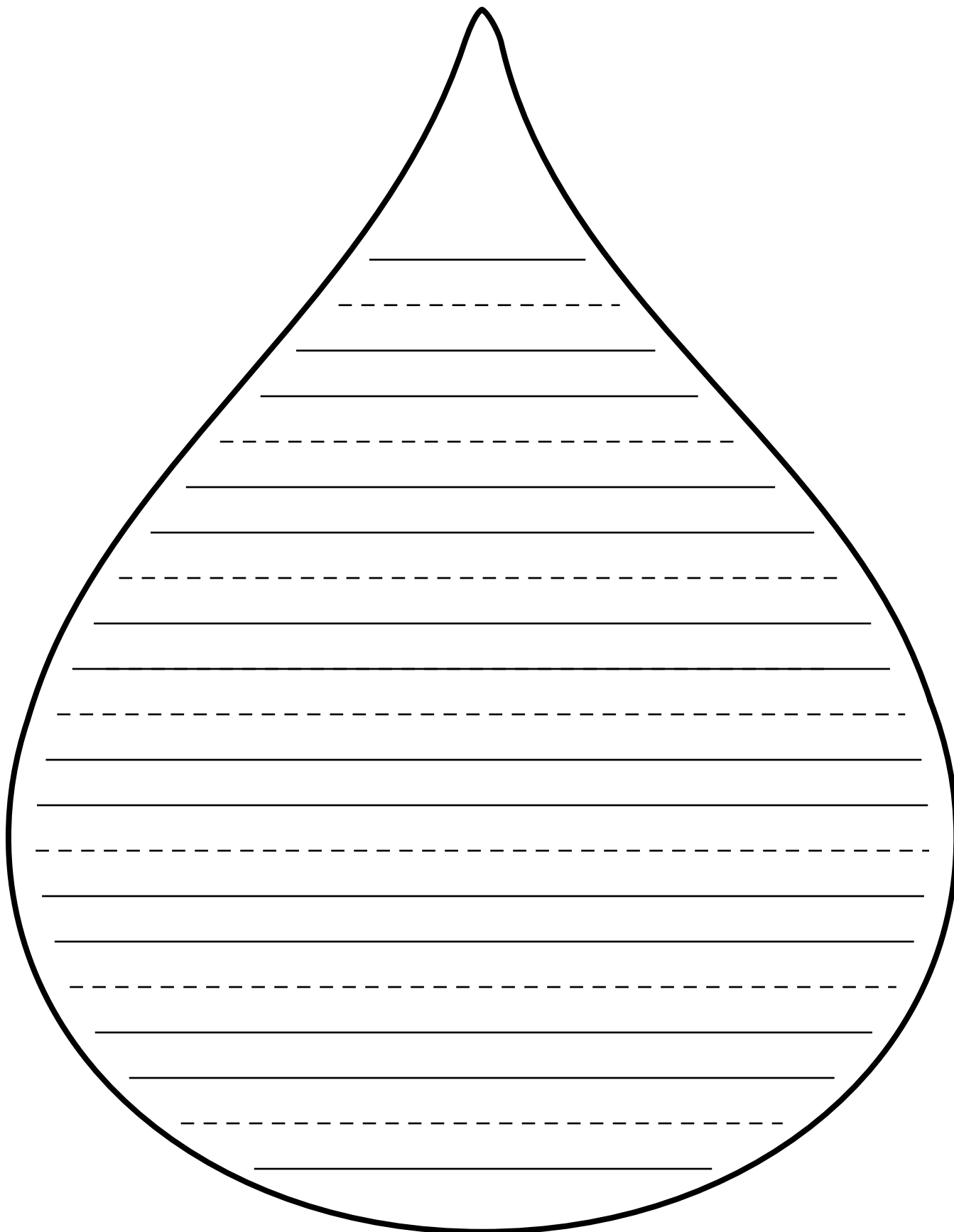

Name _____ Date _____

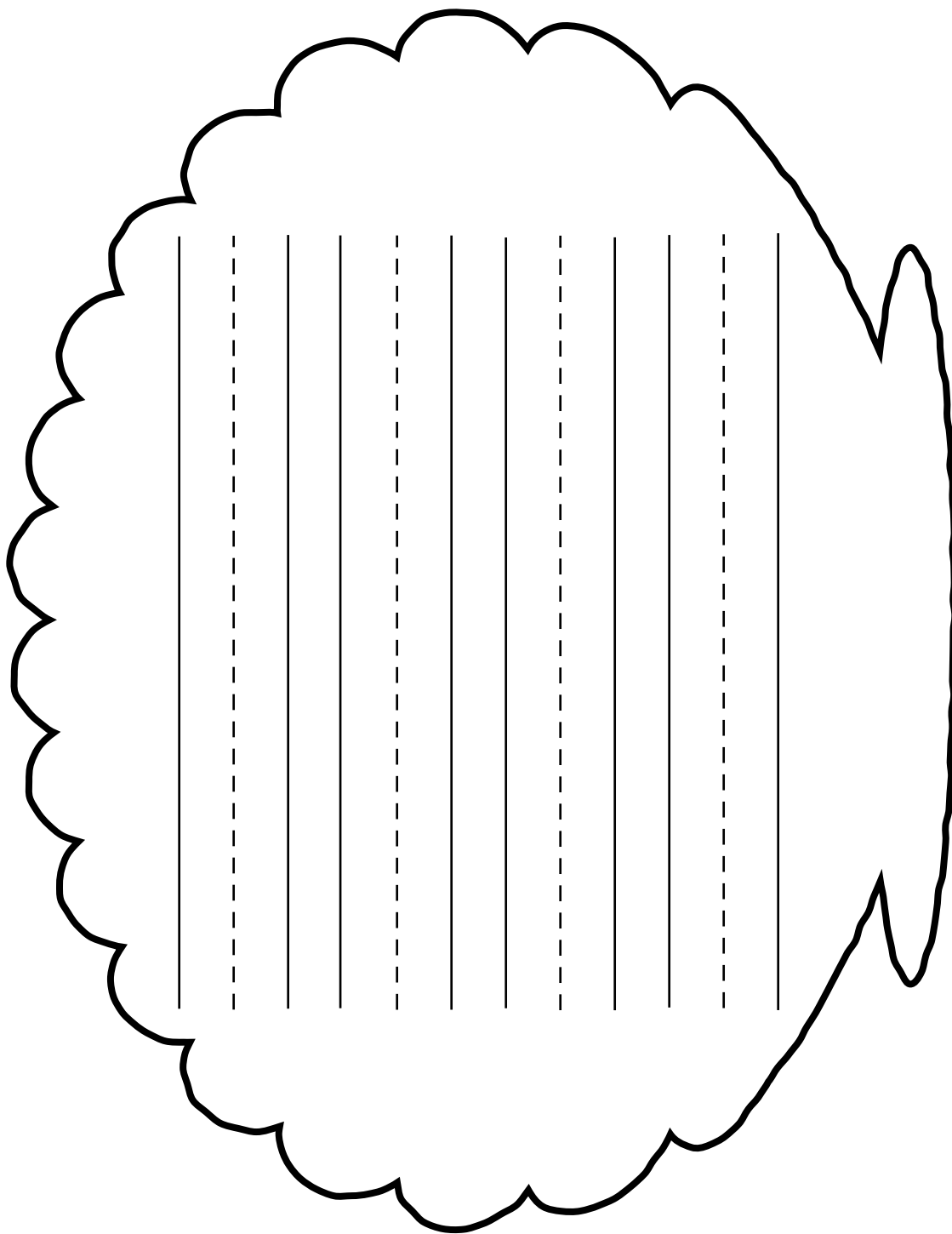

Name _____ Date _____

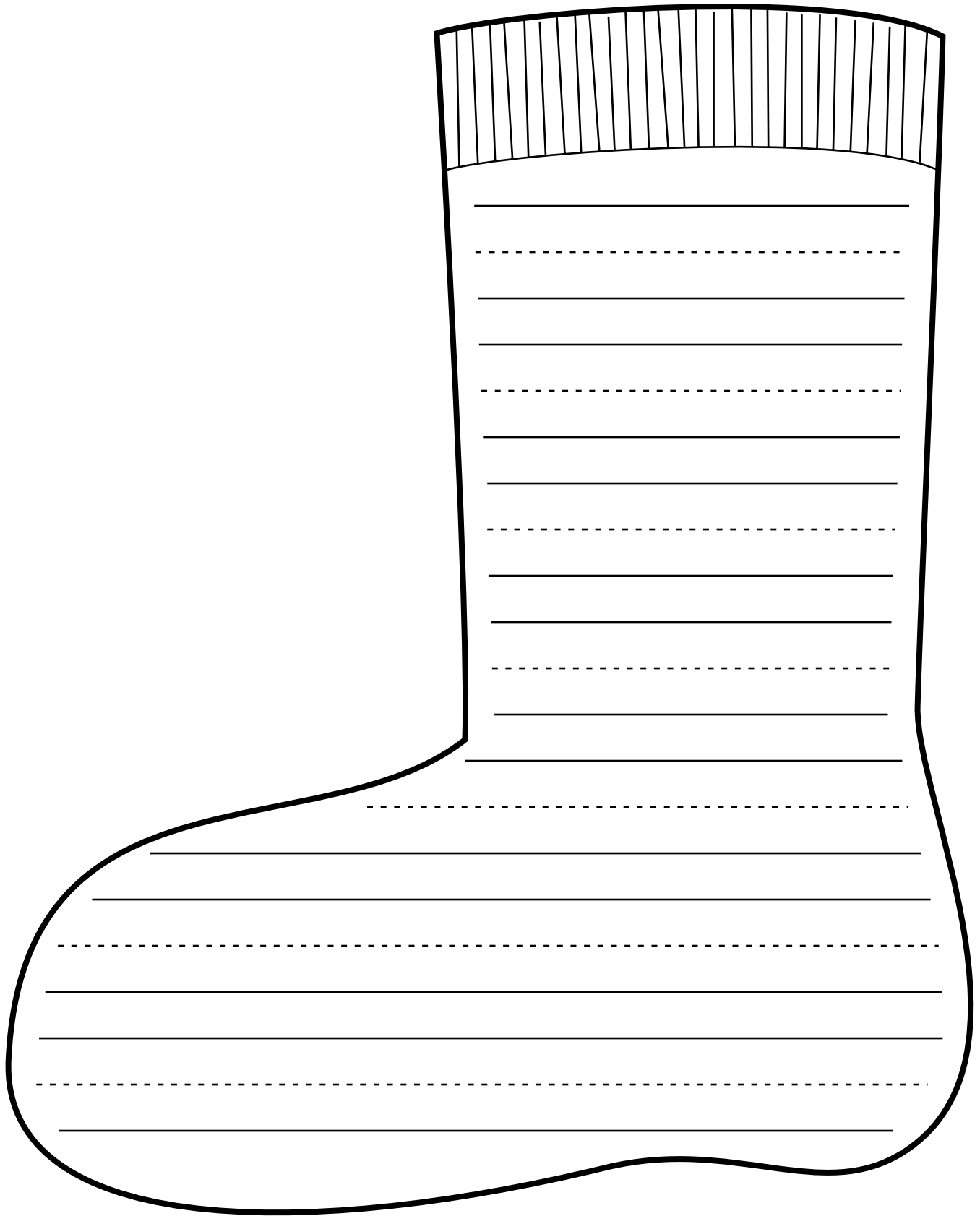

Name _____ Date _____

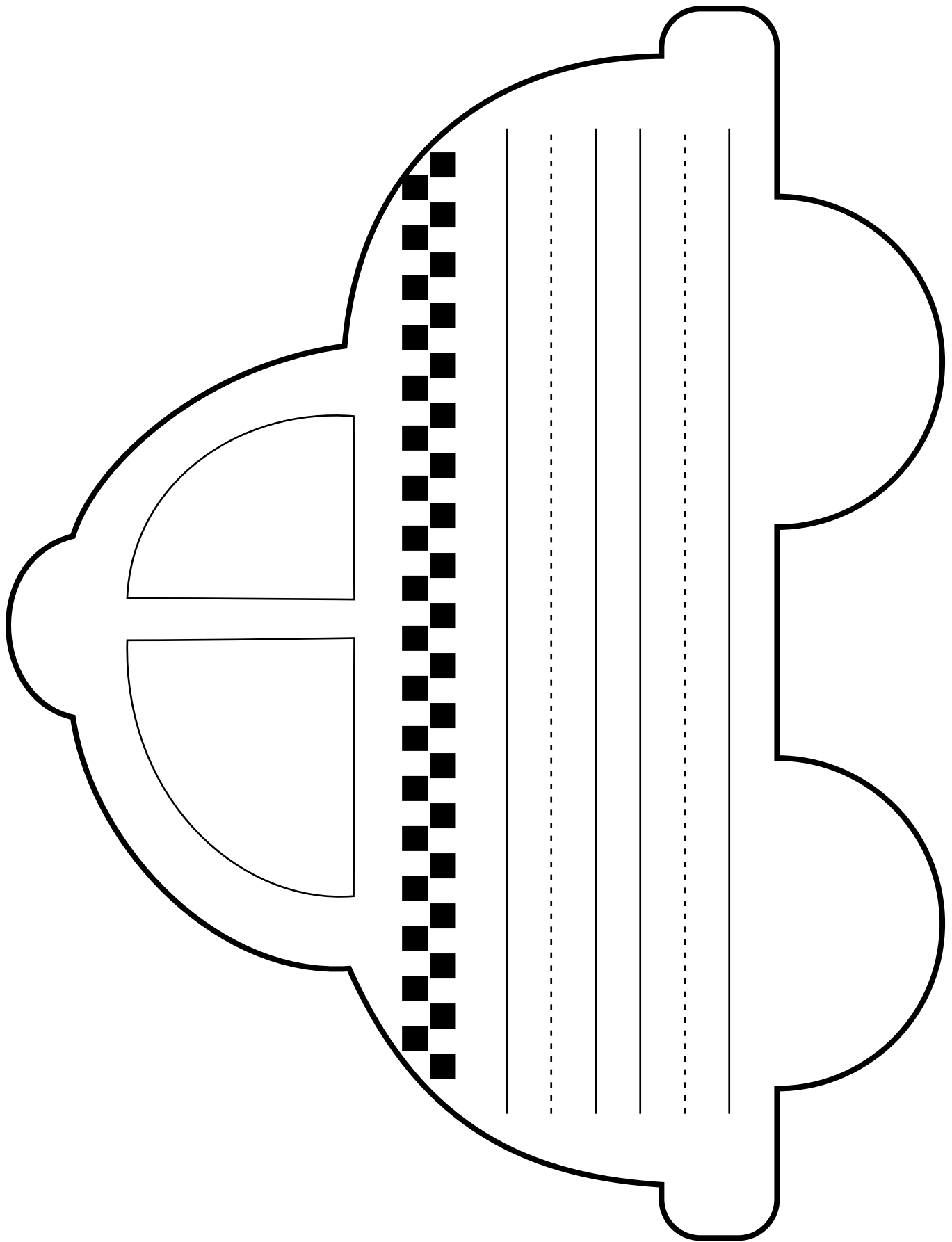

Name _____ Date _____

Name _____ Date _____

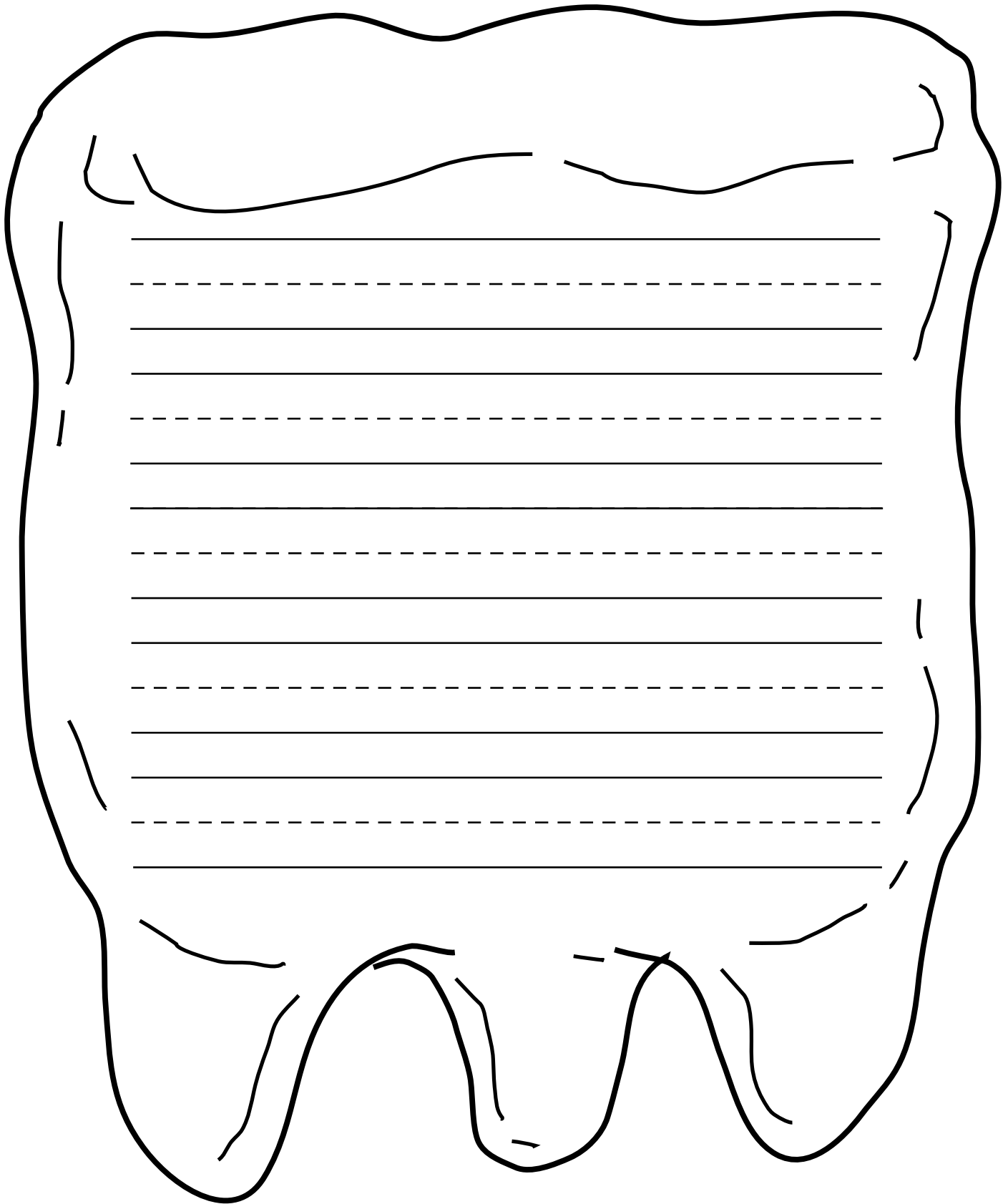

Name _____ Date _____

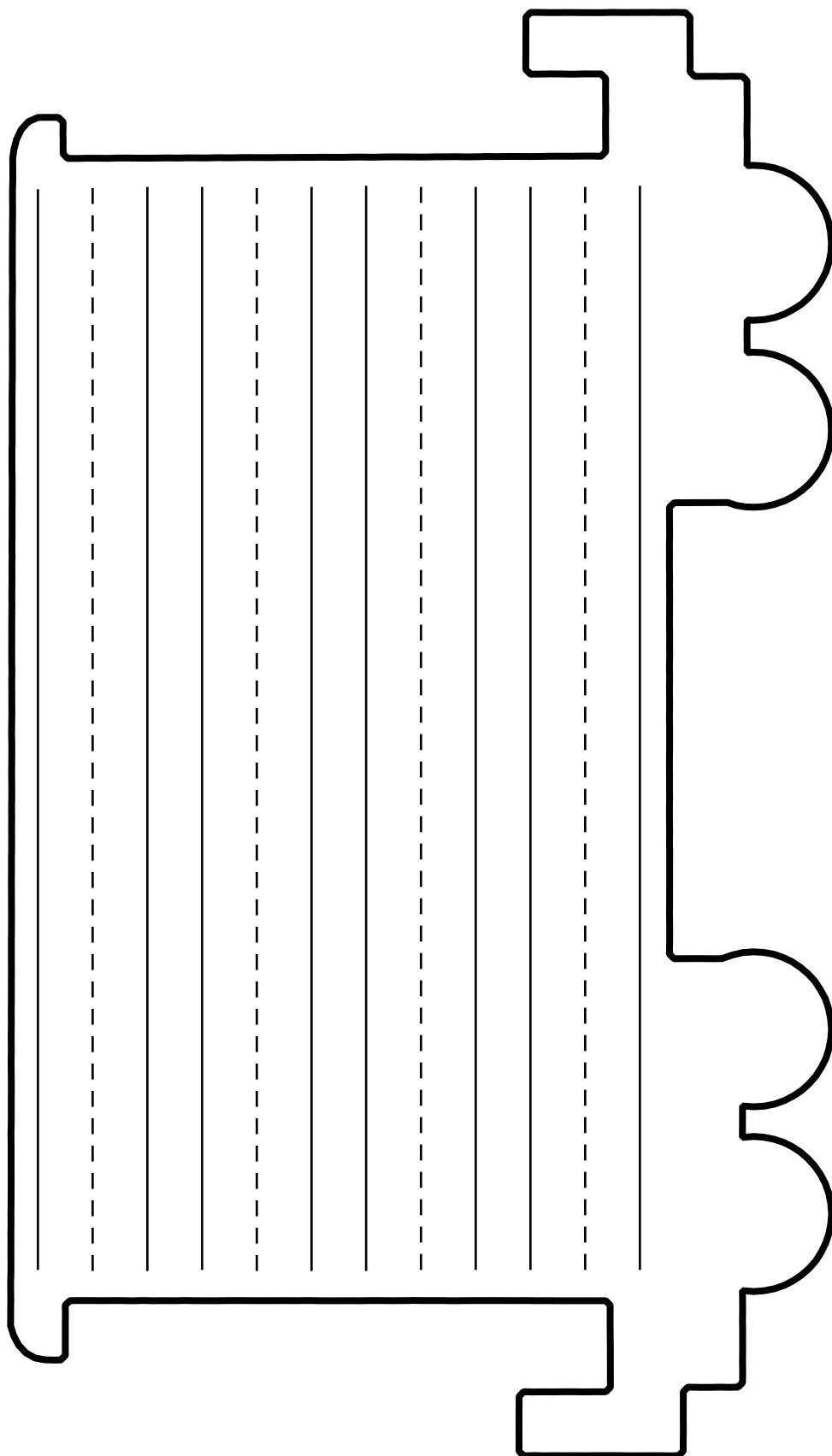

Name _____ Date _____

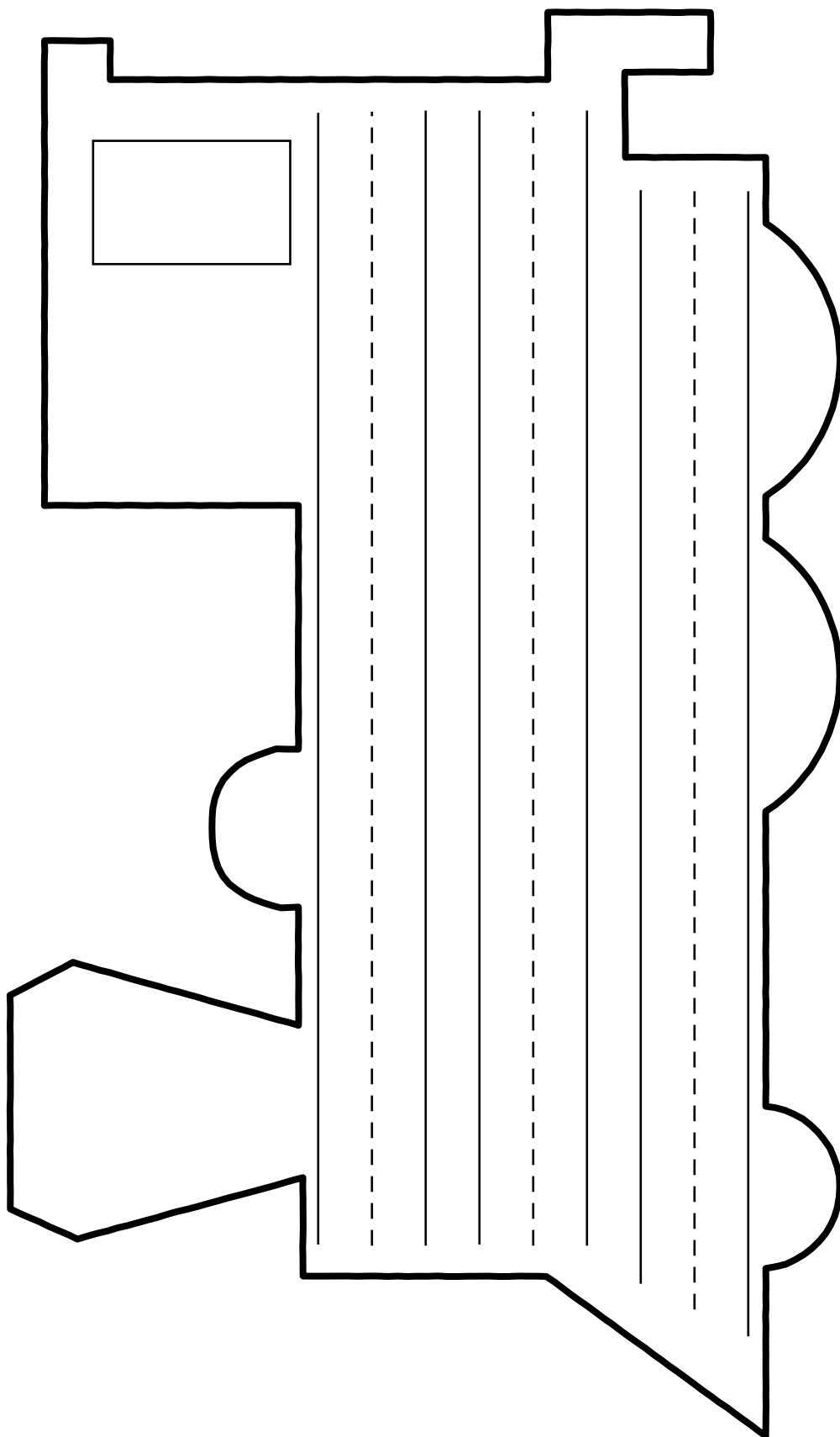

Name _____ Date _____

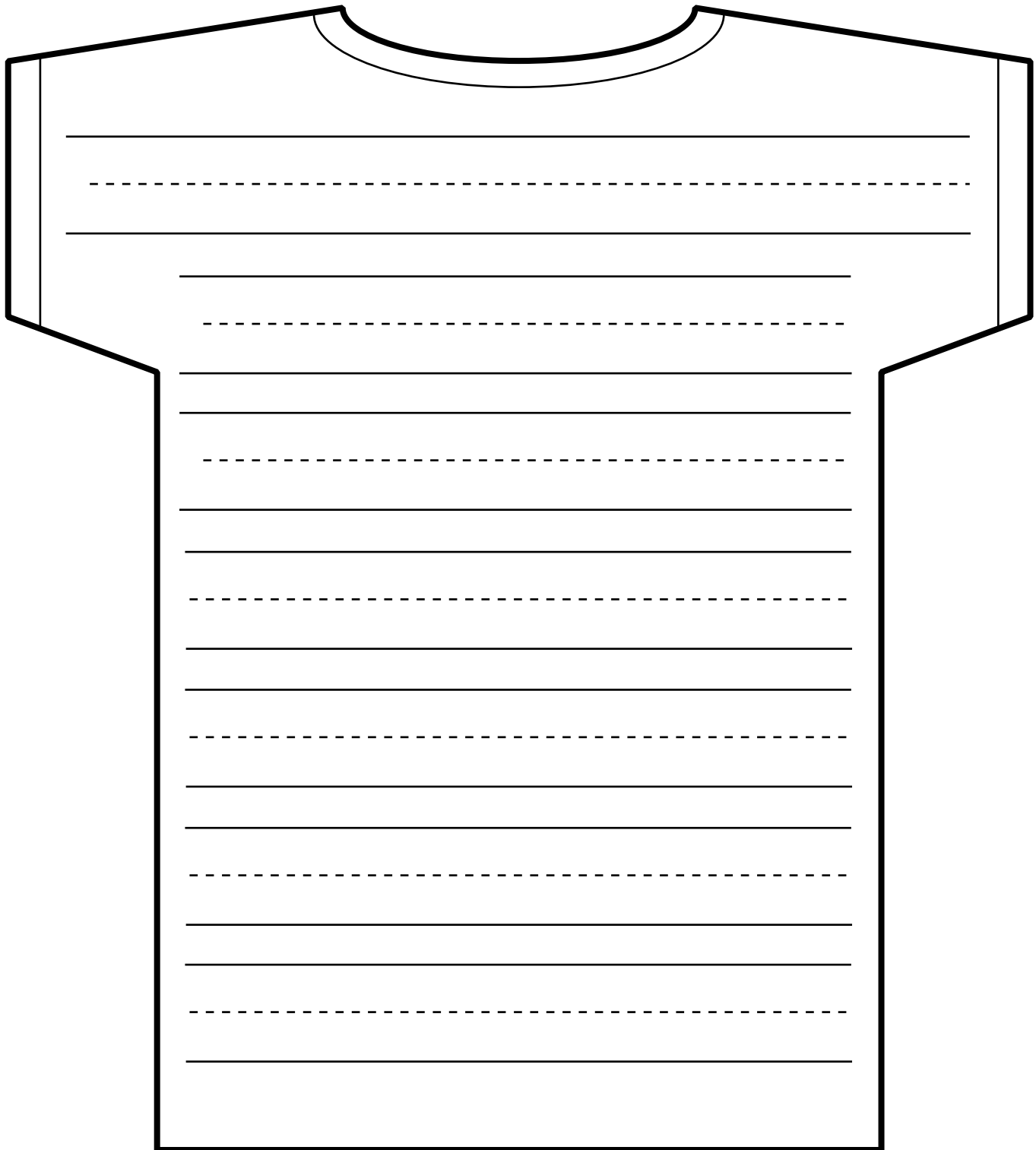

Name _____ Date _____

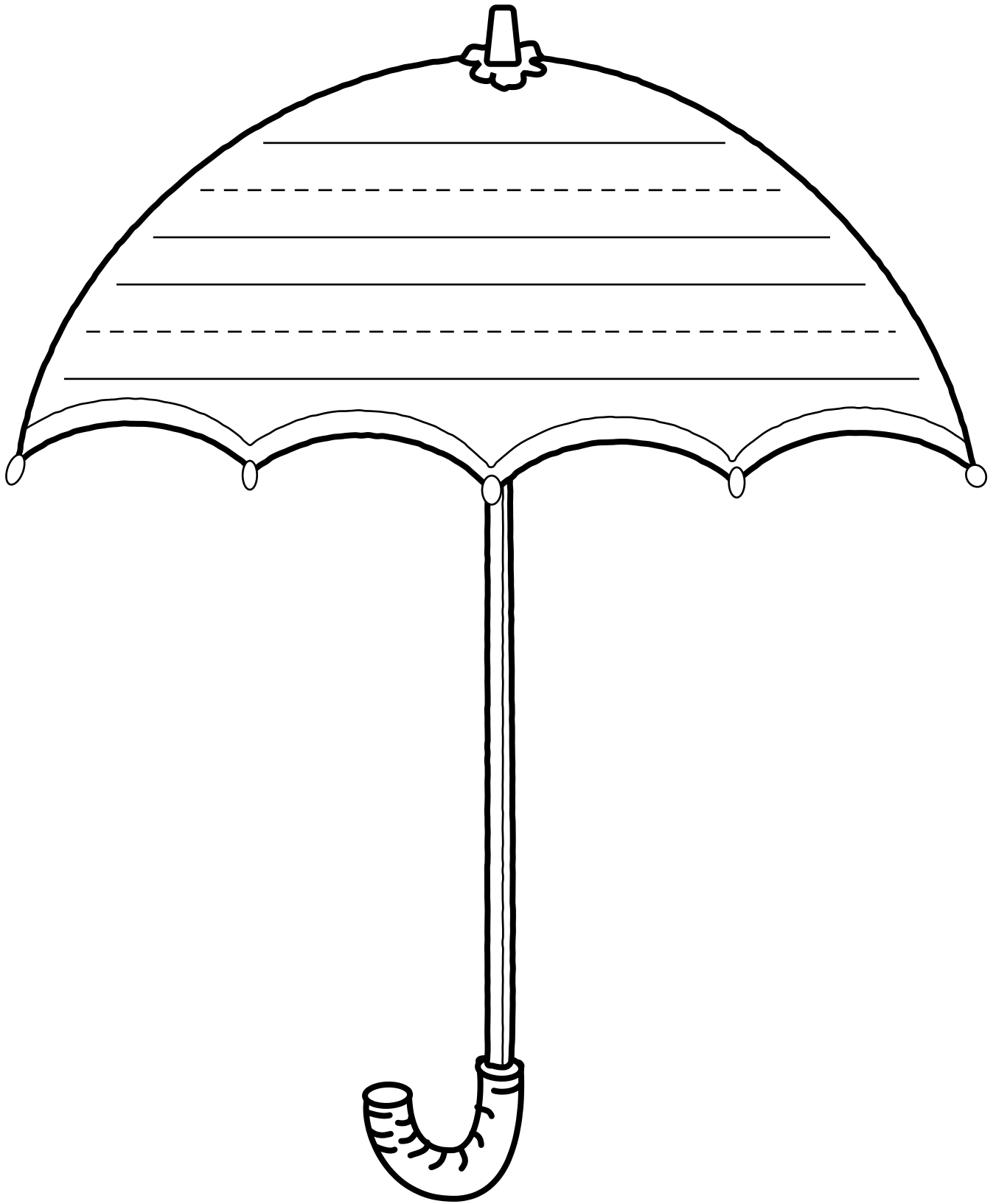

Name _____ Date _____

